



WITTENSTEIN

alpha

TP⁺

Operating Manual



2022-D033543

Revision: 04

Revision history

Revision	Date	Comment	Chapter
01	07.05.09	New version	All
02	01.08.09	Machinery Directive	1, 2, 3, 4, 6
03	14.12.11	Safety	All
03a	04.01.13	Cross reference	7.1.2
04	14.07.14	Clamping hub	5.2, 9.1

Service

In case you have technical questions,
please contact:

WITTENSTEIN alpha GmbH

Customer Service
Walter-Wittenstein-Straße 1
D-97999 Igersheim

Tel.: +49 7931 493-10900

Fax: +49 7931 493-10903

E-mail: service-alpha@wittenstein.de



Motor mounting video

© WITTENSTEIN alpha GmbH 2014

This documentation is copyright protected.

WITTENSTEIN alpha GmbH reserves all the rights to photo-mechanical reproduction, copying, and the distribution by special processes (such as computers, file media, data networks), even in parts.

Subject to technical and content changes without notice.

Contents

1	Regarding this manual	2
1.1	Signal words	2
1.2	Safety symbols	3
1.3	Design of the safety instructions	3
1.4	Information symbols	3
2	Safety	4
2.1	EC –Machinery directive	4
2.2	Dangers	4
2.3	Personnel	4
2.4	Intended use	4
2.5	Reasonably predictable misuse	4
2.6	Guarantee and liability	5
2.7	General safety instructions	5
3	Description of the gearhead	7
3.1	Overview of the gearhead components	7
3.2	Type plate	8
3.3	Ordering code	8
3.4	Performance statistics	8
3.5	Weight	9
3.6	Noise emission	9
4	Transport and storage	10
4.1	Scope of delivery	10
4.2	Packaging	10
4.3	Transport	10
4.3.1	Transport of gearheads up to and including size TP ⁺ 050	10
4.3.2	Transport of gearheads as of size TP ⁺ 110	10
4.4	Storage	10
5	Assembly	11
5.1	Preparations	11
5.2	Mounting the motor onto the gearhead	12
5.3	Mounting the gearhead to a machine	13
5.4	Mounted components on the gear output side	13
6	Startup and operation	14
7	Maintenance and disposal	15
7.1	Maintenance work	15
7.1.1	Visual inspection	15
7.1.2	Checking the tightening torques	15
7.2	Startup after maintenance work	15
7.3	Maintenance schedule	15
7.4	Notes on the lubricant used	16
7.5	Disposal	16
8	Malfunctions	17
9	Appendix	18
9.1	Details regarding the attachment to a motor	18
9.2	Specifications on mounting on the gear output side	19
9.3	Specifications on mounting onto a machine	20
9.4	Tightening torques for common thread sizes in general mechanical engineering	20

1 Regarding this manual

These instructions contain necessary information for the safe operation of the planetary gearhead TP+, referred to as gearhead in the following.

If this manual is supplied with an amendment (e.g. for special applications), then the information in the amendment is valid. Contradictory specifications in this manual thereby become obsolete.

The operator must ensure that these instructions are read through by all persons assigned to install, operate, or maintain the gearhead, and that they fully comprehend them.

Store these instructions within reach of the gearhead.

These **safety instructions** should be shared with colleagues working in the vicinity of the device to ensure individual safety.

The original instructions were prepared in German; all other language versions are translations of these instructions.

1.1 Signal words

The following signal words are used to indicate possible hazards, prohibitions, and important information:

	<p style="text-align: center;">⚠ DANGER</p> <p>This signal word points out to an imminent danger that can cause serious injuries and even death.</p>
	<p style="text-align: center;">⚠ WARNING</p> <p>This signal word points out to a possible danger that can cause serious injuries and even death.</p>
	<p style="text-align: center;">⚠ CAUTION</p> <p>This signal word points out to a possible danger that can cause slight to serious injuries.</p>
	<p style="text-align: center;">NOTICE</p> <p>This signal word points out to a possible danger that can cause material damage.</p>
	<p>A note without a signal word indicates application tips or especially important information for handling the gearhead.</p>

1.2 Safety symbols

The following safety symbols are used to bring your attention to dangers, prohibitions, and important information:



General danger



Hot surface



Suspended loads



Danger of being pulled in



Environment protection



Information

1.3 Design of the safety instructions

The safety instructions of these instructions are designed according to the following pattern:

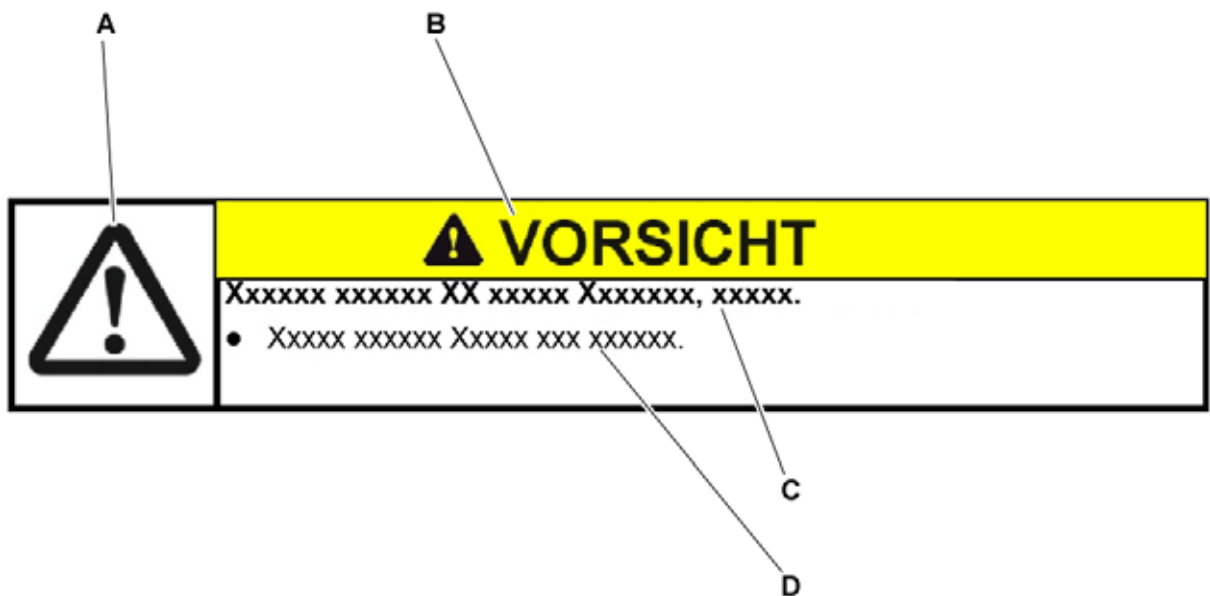

A = Safety symbol (see Chapter 1.2 "Safety symbols")

B = Signal word (see Chapter 1.1 "Signal words")

C = Type and consequence of the danger

D = Prevention of the danger

1.4 Information symbols

The following information symbols are used:

- Indicates an action to be performed
- ➔ Indicates the results of an action
- ⓘ Provides additional information on handling

2 Safety

These instructions, especially the safety instructions and the rules and regulations valid for the operating site, must be observed by all persons working with the gearhead.

In addition to the safety specifications mentioned in this operating manual, the general and also the local regulations on the prevention of accidents (for instance, personal safety equipment) and on environmental protection should be observed.

2.1 EC –Machinery directive

The gearhead is considered a "machine component" and is therefore not subject to the EC Machinery Directive 2006/42/EC.

Operation is prohibited within the area of validity of the EC directive until it has been determined that the machine in which this gearhead is installed corresponds to the regulations within this directive.

2.2 Dangers

The gearhead has been constructed according to current technological standards and accepted safety regulations.

To avoid danger to the operator or damage to the machine, the gearhead may be put to use only for its intended usage (see chapter 2.4 "Intended use") and in a technically flawless and safe state.

- Be informed of the general safety instructions before beginning work (see Chapter 2.7 "General safety instructions").

2.3 Personnel

Only persons who have read and understood these instructions may carry out work on the gearhead.

2.4 Intended use

The gearhead serves to convert torques and speeds. It is built for industrial applications that do not fall under Article 2 of the EC Directive 2011/65/EU (Restriction of the use of certain hazardous substances in electrical and electronic equipment).

The gearhead may not be operated in areas with explosion hazards. In food processing, the gearhead may be used only next to or under the foodstuff area.

The gearhead is specified for installment on motors that:

- correspond to the design B5 (for any deviations, consult our Customer Service department [technical Customer Service department]).
- show a radial and axial runout tolerance according to DIN EN 50347.
- have a smooth cylindrical shaft end with tolerance class h6 to k6.

2.5 Reasonably predictable misuse





Any usage that exceeds the maximum permitted speeds, torques and temperature is considered a misuse and is therefore prohibited.



2.6 Guarantee and liability

Guarantee and liability claims are excluded for personal injury and material damage in case of

- Ignoring the information on transport and storage
- Improper use (misuse)
- Improper or neglected maintenance and repair
- Improper assembly / disassembly or improper operation (e.g. test run without secure attachment)
- Operation of the gearhead when safety devices and equipment are defective
- Operation of the gearhead without lubricant
- Operation of a heavily soiled gearhead
- Modifications or reconstructions that have been carried out without the approval of **WITTENSTEIN alpha GmbH**

2.7 General safety instructions

	<p style="text-align: center;">⚠ WARNING</p> <p>Objects flung out by rotating components can cause serious injuries.</p> <ul style="list-style-type: none"> • Remove objects and tools from the gearhead before putting it into operation. • Remove/Secure the shaft key (if available) if the gearhead is operated without attachments on the output/drive side.
	<p style="text-align: center;">⚠ WARNING</p> <p>Rotating components on the gearhead can pull in parts of the body and cause serious injuries and even death.</p> <ul style="list-style-type: none"> • Keep a sufficient distance to rotating machinery while the gearhead is running. • Secure the machine against restarting and unintentional movements during assembly and maintenance work (e.g. uncontrolled lowering of lifting axes).
	<p style="text-align: center;">⚠ WARNING</p> <p>A damaged gearhead can cause accidents and injury.</p> <ul style="list-style-type: none"> • Never use a gearhead that has been overloaded to due misuse or a machine crash (see chapter 2.5 "Reasonably predictable misuse"). • Replace the affected gearhead, even if no external damage is visible.
	<p style="text-align: center;">⚠ CAUTION</p> <p>Hot gearhead housing can cause serious burns.</p> <ul style="list-style-type: none"> • Touch the gearhead housing only when wearing protective gloves or after the gearhead has been at standstill for some time.
	<p style="text-align: center;">NOTICE</p> <p>Loose or overloaded screw connections can damage the gearhead.</p> <ul style="list-style-type: none"> • Use a calibrated torque wrench to tighten and check all screw connections for which a tightening torque has been specified.

	<p style="text-align: center;">⚠ WARNING</p> <p>Lubricants are flammable.</p> <ul style="list-style-type: none">• Do not spray with water to extinguish.• Suitable extinguishing agents are powder, foam, water mist, and carbon dioxide.• Observe the safety instructions of the lubricant manufacturer (see Chapter 7.4 "Notes on the lubricant used").
	<p style="text-align: center;">⚠ CAUTION</p> <p>Solvents and lubricants can cause skin irritations.</p> <ul style="list-style-type: none">• Avoid direct skin contact.
	<p>Solvents and lubricants can pollute soil and water.</p> <ul style="list-style-type: none">• Use and dispose of cleaning solvents as well as lubricants appropriately.

3 Description of the gearhead

The gearhead is a single- or multi-stage, low-backlash planetary gearhead that is manufactured as standard in the following versions:

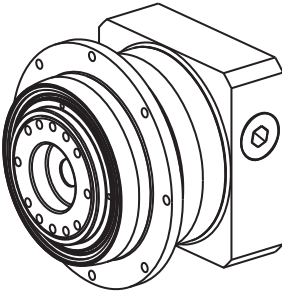
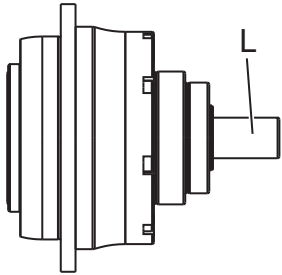
	<p>"M" (motor-mounted gearhead)</p> <p>Motor centering of the motor-mounted gearhead is performed:</p> <ul style="list-style-type: none"> - up to gearhead size TP+ 025 and a motor shaft diameter of 28 mm by the clamping hub (socket or coupling) - from gearhead size TP+ 050 and a motor shaft diameter of >28 mm through the centering collar of the motor <p>A radial distortion of the motor is avoided.</p> <p>Adaptation to various motors is done by an adapter plate and a bushing.</p> <p>The output flange bearing is designed to withstand high tilting moments and axial forces.</p> <p>The gearhead can be optionally constructed with a coupling to compensate for thermal linear expansion.</p>
	<p>"S" (self-contained gearhead)</p> <p>The self-contained gearhead is based on the motor-mounted gearhead and additional mounting parts, such as drive housing and drive shaft (L). It is possible to drive the gearhead directly via the drive shaft, e.g. by means of a belt pulley.</p> <p>The drive and output flange bearing are designed to withstand high tilting moments and axial forces.</p>

3.1 Overview of the gearhead components

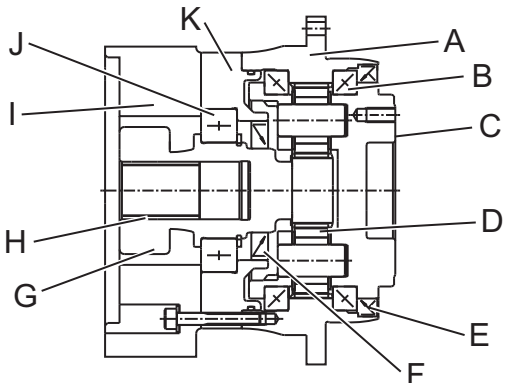
		Gearhead components
		A Gearhead housing
		B Output bearing
		C Output flange
		D Planetary gear stage
		E Radial shaft sealing ring
		F Radial shaft sealing ring
		G Clamping hub (plug receptacle / coupling)
		H Bushing
		I Adapter plate
		J Drive bearing arrangement
		K Drive housing

Tbl-1: Overview of the gearhead components

3.2 Type plate

The type plate is attached to the gearhead housing as well input flange.

		Designation
	A	Ordering key (see Chapter 3.3 "Ordering code")
	B	Ratio
	C	Serial number
	D	Lubricant
	E	Production date

Tbl-2: Type plate (sample values)

3.3 Ordering code

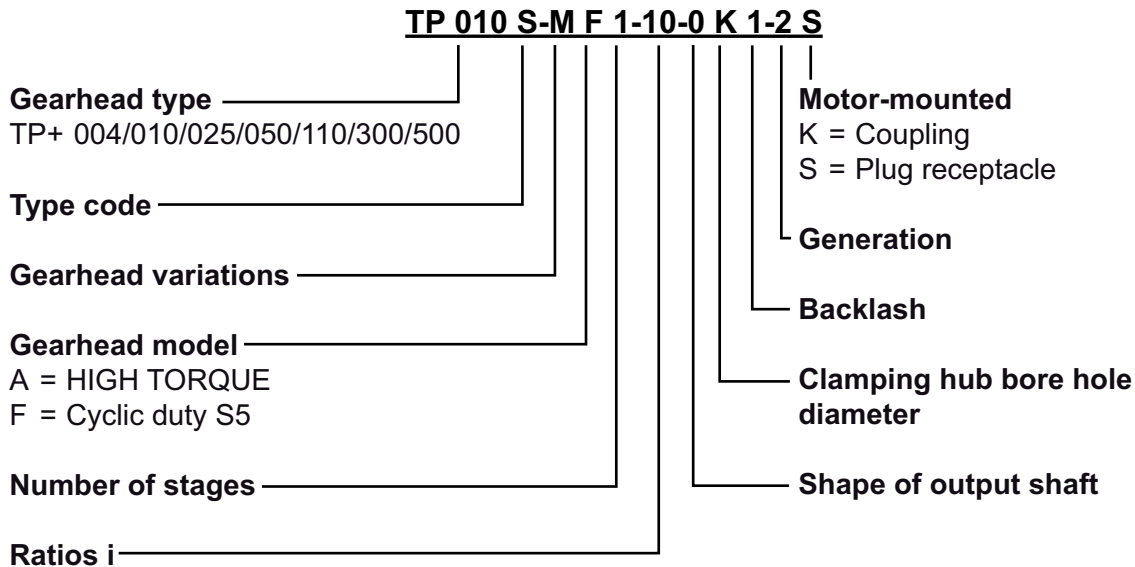

Refer to our catalog or our website at <http://www.wittenstein-alpha.de> for further information.

3.4 Performance statistics

For the maximum permitted speeds and torques, refer to

- our catalog,
- our website <http://www.wittenstein-alpha.de>,
- the respective customer-specific performance data (2093–D...).

	<p>Consult our Customer Service department if the gearhead is older than a year. You will then receive the valid performance data.</p>
--	---

3.5 Weight

The table "Tbl-3" specifies the gearhead weights with a medium-sized adapter plate. If a different adapter plate is mounted, the actual weight can deviate by up to 10 %.

Gearhead size TP+		004	010	025	050	110	300	500
Version	Stages							
M	1	1.4	3.8	6.5	14.0	30.0	60.0	82.0
	2	1.5	3.6	6.7	14.1	34.0	58.5	77.5
MA	1	-	-	-	-	-	55.0	80.0
	2	-	3.2	5.6	12.5	33.1	64.0	80.0
	3	-	3.6	6.1	13.4	35.4	67.0	89.0
S	1	1.8	3.9	6.1	11.7	29.8	on request	
	2	2.3	4.1	8.5	15.8	33.6		

Tbl-3: Weight [kg]

3.6 Noise emission

Depending on the gearhead type and product size, the continuous sound pressure level is up to 68 dB(A).

- ① For specifications on your particular product, refer to our catalogue or our Internet page at <http://www.wittenstein-alpha.de> or contact our Customer Service department.
- Observe the total noise pressure level of the machine.

4 Transport and storage

4.1 Scope of delivery



- Check the completeness of the delivery against the delivery note.
 - ① Missing parts or damage must be notified immediately in writing to the carrier, the insurance, or **WITTENSTEIN alpha GmbH**.

4.2 Packaging

The gearhead is delivered packed in foil and cardboard boxes.

- Dispose of the packaging materials at recycling sites intended for that. Observe the locally valid regulations for disposals.

4.3 Transport

	⚠ WARNING
	<p>Suspended loads can fall and can cause serious injuries and even death.</p> <ul style="list-style-type: none"> • Do not stand under suspended loads. • Secure the gearhead before transport with suitable fasteners (e.g. belts).
	NOTICE
	<p>Hard knocks, because of falling or hard dropping, can damage the gearhead.</p> <ul style="list-style-type: none"> • Only use hoisting equipment and transports with sufficient capacity. • The maximum permitted lift capacity of a hoist may not be exceeded. • Lower the gearhead slowly.

Specifications on the weights, refer to Chapter 3.5 "Weight".

4.3.1 Transport of gearheads up to and including size TP+ 050

No special transport mode is prescribed for transporting the gearhead.

4.3.2 Transport of gearheads as of size TP+ 110

For gearheads of size TP+ 110 or greater, we recommend the use of hoisting equipment.

4.4 Storage

Store the gearhead in horizontal position and dry surroundings at a temperature of 0 °C to +40 °C in the original packaging. Store the gearhead for a maximum of 2 years. Consult our Customer Service department if the conditions are different.

For storage logistics, we recommend the "first in –first out" method.

5 Assembly

- Be informed of the general safety instructions before beginning work (see Chapter 2.7 "General safety instructions").

5.1 Preparations

There are two centering mechanisms for assembling the gearhead to the machine:

		Centering
	A	output side (standard)
	B	motor side (option) ⓘ Information on assembly with centering on the motor side can be found on our Internet page: www.wittenstein-alpha.de/download or contact our Customer Service department.

Tbl-4: Centering mechanisms

	NOTICE
	<p>Pressurized air can damage the gearhead seals.</p> <ul style="list-style-type: none"> • Do not use pressurized air to clean the gearhead.

	NOTICE
	<p>Directly sprayed cleaning agents can alter the frictional values of the clamping hub.</p> <ul style="list-style-type: none"> • Only spray cleaning agents onto a cloth for wiping off the clamping hub.

- Check that the motor meets the specifications in Chapter 2.4 "Intended use".
- Clean/De-grease and dry the following components with a clean and lint-free cloth and grease-dissolving, non-aggressive detergent:
 - All fitting surfaces to neighboring components
 - Centering
 - The motor shaft
 - The inner diameter of the clamping hub
 - The bushing, inside and out
- Dry all fitting surfaces to neighboring components in order to achieve the proper friction values of the screw connections.
- Check the fitting surfaces additionally for damage and impurities.
- Select screws for fastening the motor to the adapter plate according to the motor manufacturer's specifications. Observe the minimum screw depth as determined by the property class (see Table "Tbl-5").

Property class of the screws for fastening the motor	8.8	10.9
Minimum screw depth	1.5 x d	1.8 x d
d = Screw diameter		

Tbl-5: Minimum screw depth of the screws for fastening the motor to the adapter plate

5.2 Mounting the motor onto the gearhead

	<ul style="list-style-type: none"> ● Observe the specifications and safety instructions of the motor manufacturer. ● Observe the safety and processing instructions of the screw-bonding agents to be used.
--	---

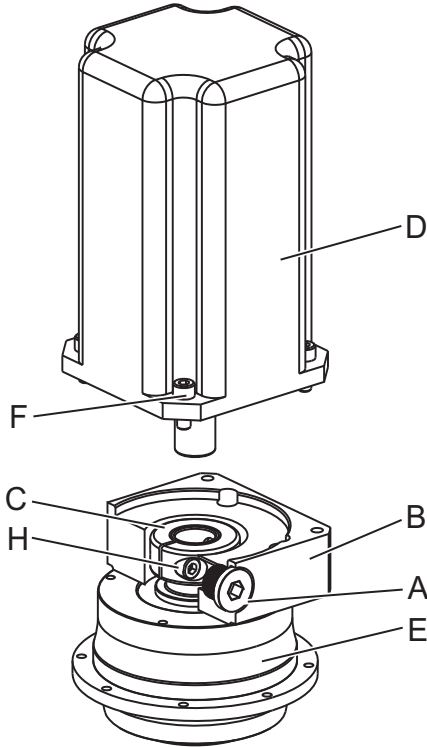

- Ensure that the motor is mounted if possible in a vertical direction.
- If the motor shaft has a shaft key, remove it.
 - ① If recommended by the motor manufacturer, insert a half wedge.
- Remove the plug (A) from the mounting bore in the adapter plate (B).
- Turn the clamping hub (C) until the clamping bolt (H) can be reached via the mounting bore.
- Loosen the clamping bolt (H) of the clamping hub (C) by one revolution.
- Push the motor shaft into the clamping hub of the gearhead (E).
 - ① The motor shaft should slip in easily. If this is not the case, the clamping bolt needs to be loosened some more.
 - ① A slotted bushing has to be additionally installed for certain motor shaft diameters and applications.
 - ① The slot of the bushing (if present) and clamping hub have to be flush with the groove (if present) of the motor shaft, see Table "Tbl-6".
 - ① No gap is permitted between motor (D) and the adapter plate (B).

		Designation
		H
		I
		J
		K
		L

Tbl-6: Arrangement of motor shaft, clamping hub, and bushing

① Motor centering of the motor-mounted gearhead is performed:

- up to gearhead size TP+ 025 and a motor shaft diameter of 28 mm by the clamping hub (socket or coupling)
- from gearhead size TP+ 050 and a motor shaft diameter of >28 mm through the centering collar of the motor

- Coat the four bolts (F) with a threadlocker (e.g. Loctite 243).
- Fasten the motor (D) onto the adapter plate (B) with the four screws.
- Tighten the clamping bolt (H) of the clamping hub (C).
 - ① For screw sizes and specified tightening torques, see Chapter 9.1 "Details regarding the attachment to a motor", Table "Tbl-12".
- Screw in plug (A) of the adapter plate (B).
 - ① For screw sizes and specified tightening torques, see Table "Tbl-7".

Width across flats [mm]	5	8	10	12	14
Tightening torque [Nm]	10	35	50	70	140

Tbl-7: Tightening torque for the plug

5.3 Mounting the gearhead to a machine

- Observe the safety and processing instructions of the screw-bonding agents to be used.

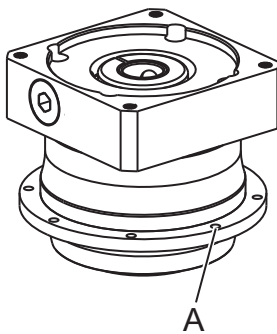

- Center the gearhead in the machine base.
- Coat the fastening screws with a threadlocker (e.g. Loctite 243).
- Fasten the gearhead to the machine by screwing the fastening screws through the through-holes (A).
 - ① Mount the gearhead in such a way that the identification plate remains legible.
 - ① Do not use washers (e.g. plain washers, tooth lock washers).
 - ① For specified screw sizes and tightening torques, see Chapter 9.3 "Specifications on mounting onto a machine", Table "Tbl-14".

5.4 Mounted components on the gear output side



NOTICE

Distortions during mounting operations can damage the gearhead.

- Mount gearwheels and toothed belt pulleys onto the output flange without forcing.
- Do not on any account attempt an assembly by force or hammering!
- Only use suitable tools and equipment for assembly.

- ① For prescribed screw sizes and tightening torques refer to Chapter 9.2 "Specifications on mounting on the gear output side", table "Tbl-13".

6 Startup and operation

- Be informed of the general safety instructions before beginning work (see Chapter 2.7 "General safety instructions").

	<p>Improper use can cause damage to the gearhead.</p> <ul style="list-style-type: none">● Make sure that<ul style="list-style-type: none">- the ambient temperature does not drop below -15 °C or exceed $+40\text{ °C}$ and- the operating temperature does not exceed $+90\text{ °C}$.● Avoid icing, which can damage the seals.● For other conditions of use, consult our Customer Service department.● Only use the gearhead only up to its maximum limit values, see Chapter 3.4 "Performance statistics".● Only use the gearhead only in a clean, dust-free and dry environment.
--	--

7 Maintenance and disposal

- Be informed of the general safety instructions before beginning work (see Chapter 2.7 "General safety instructions").

7.1 Maintenance work

7.1.1 Visual inspection

- Check the entire gearhead for exterior damage.
- The radial shaft seals are subject to wear. Therefore also check the gearhead for leakage during each visual inspection.
 - ① You can find more general information on radial shaft seals on our partner's Internet site at <http://www.simrit.de>.
 - ① Check the mounting position, so that no foreign medium (e.g. oil) has collected on the output flange.

7.1.2 Checking the tightening torques

- Check the tightening torques of the clamping bolt on the motor mounting as well as the fastening screws on the output flange. If you discover while checking the tightening torque that the clamping bolt can be turned further, tighten it with the prescribed tightening torque.
 - ① The prescribed tightening torques can be found in Chapter 9.1 "Details regarding the attachment to a motor", Table "Tbl-12" and in Chapter 9.2 "Specifications on mounting on the gear output side", Table "Tbl-13".
- Check the tightening torque of the fastening screws on the gearhead housing. If, while checking the tightening torque, you discover that a fastening screw can be further tightened, follow the instructions in "Remount the screw".
 - ① The prescribed tightening torques can be found in Chapter 9.3 "Specifications on mounting onto a machine", Table "Tbl-14".

Remount the screw

	<ul style="list-style-type: none"> ● Make sure that it is possible to remount the screw on the gearhead without damaging any part of the machine.
--	--

- Loosen the screw.
- Remove the residue glue from the threaded bore and from the screw.
- De-grease the screw.
- Coat the screw with a threadlocker (e.g. Loctite® 243).
- Screw in the screw and tighten it with the prescribed tightening torque.

7.2 Startup after maintenance work

- Clean the outside of the gearhead.
- Attach all safety devices.
- Do a trial run before releasing the gearhead again for operation.

7.3 Maintenance schedule

Maintenance work	At startup	First time after 500 operating hours or 3 months	Every 3 months	Yearly
Visual inspection	X	X	X	
Checking the tightening torques	X	X		X

Tbl-8: Maintenance schedule

7.4 Notes on the lubricant used

	All gearheads are permanently lubricated by the manufacturer with synthetic gear oil (polyglycols) of viscosity class ISO VG100, ISO VG220 or with a high-performance lubricant (see type plate). All bearings are permanently lubricated by the company.
---	---

The manufacturer listed below will provide any further information on the lubricants:

Standard lubricants	Lubricants for the food industry (NSF-H1 registered)
Castrol Industrie GmbH, Mönchengladbach Tel.: + 49 2161 909-30 www.castrol.com	Klüber Lubrication München KG, Munich Tel.: + 49 89 7876-0 www.klueber.com



Tbl-9: Lubricant manufacturers

7.5 Disposal

Consult our Customer Service department for supplementary information on exchanging the adapter plate, on disassembly, and on disposal of the gearhead.

- Dispose of the gearhead at the recycling sites intended for this purpose.
 - ① Observe the locally valid regulations for disposals.

8 Malfunctions

	<p style="text-align: center;">NOTICE</p> <p>Changed operational behavior can be an indication of existing damage to the gearhead or cause damage to the gearhead.</p> <ul style="list-style-type: none"> Do not put the gearhead back into operation until the cause of the malfunction has been rectified.
	<p>Rectifying of malfunctions may only be done by specially trained technicians.</p>

Fault	Possible cause	Solution
Increased operating temperature	The gearhead is not suited for the task.	Check the technical specifications.
	Motor is heating the gearhead.	Check the wiring of the motor.
		Ensure adequate cooling.
	Change the motor.	
Increased noises during operation	Distortion in motor mounting	Please consult our Customer Service Department.
	Damaged bearings	
	Damaged gear teeth	
Loss of lubricant	Lubricant quantity too high	Wipe off discharged lubricant and continue to watch the gearhead. Lubricant discharge must stop after a short time.
	Seals not tight	Please consult our Customer Service Department.

Tbl-10: Malfunctions

9 Appendix

9.1 Details regarding the attachment to a motor

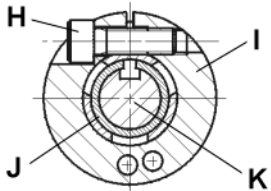
		Designation
	H	Clamping bolt
	I	Clamping ring (part of the clamping hub)
	J	Bushing
	K	Motorshaft

Tbl-11: Arrangement of motor shaft, clamping hub, and bushing

Gearhead size TP+		Clamping hub interior Ø "x" [mm]	Clamping bolt (H) / DIN ISO 4762	Width across flats [mm]	Tightening torque [Nm] property class 12.9	Max. axial force clamping hub [N]		
						Plug receptacle	Coupling	
004	1-stage	$x \leq 11$	M4	3	4.1	100	10	
		$11 < x \leq 14$	M5	4	9.5			
$14 < x \leq 19$		M6	5	14				
010	2-stage	$x \leq 11$	M4	3	4.1	80	—	
		$11 < x \leq 14$	M5	4	9.5			
025	1-stage	$x \leq 14$	M5	4	9.5	120	20	
		$14 < x \leq 19$	M6	5	14			
		$19 < x \leq 24$	M8	6	35			
		$24 < x \leq 28$	M6	5	14			
	2-stage	$x \leq 11$	M4	3	4.1	100	10	
		$11 < x \leq 14$	M5	4	9.5			
050	3-stage	$14 < x \leq 19$	M6	5	14	100	10	
		$19 < x \leq 24$	M8	6	35			
		$24 < x \leq 28$	M6	5	14			
		$28 < x \leq 38$	M10	8	79			
050	1-stage	$x \leq 14$	M5	4	9.5	120	20	
		$14 < x \leq 19$	M6	5	14			
		$19 < x \leq 24$	M8	6	35			
	2-stage	$24 < x \leq 28$	M6	5	14	150	30	
		$x \leq 19$	M6	5	14			
		$19 < x \leq 24$	M8	6	35			
	3-stage	$24 < x \leq 28$	M6	5	14	120	20	
		$x \leq 19$	M6	5	14			
		$19 < x \leq 24$	M8	6	35			
	050	1-stage	$x \leq 24$	M8	6	35	200	50
			$24 < x \leq 38$	M10	8	79		
			$38 < x \leq 48$	M12	10	135		
2-stage		$x \leq 19$	M6	5	14	150	30	
		$19 < x \leq 24$	M8	6	35			
		$24 < x \leq 38$	M10	8	79			
3-stage		$x \leq 24$	M8	6	35	150	30	
		$24 < x \leq 38$	M10	8	79			
		$38 < x \leq 48$	M12	10	135			

Gearhead size TP ⁺	Clamping hub interior Ø “x” [mm]	Clamping bolt (H) / DIN ISO 4762	Width across flats [mm]	Tightening torque [Nm] property class 12.9	Max. axial force clamping hub [N]		
					Plug receptacle	Coupling	
110	1-stage	x≤38	M10	8	79	250	200
		38 < x ≤48	M12	10	135		
	2-stage	x≤24	M8	6	35	200	50
		24 < x ≤38 38 < x ≤48	M10 M12	8 10	79 135		
3-stage	x≤38	M10	8	79	200	50	
300	1-stage	x≤55	M12	10	135	300	—
	2-stage	x≤48	M12	10	135	250	—
	3-stage	x≤38	M10	8	79	250	—
500	1-stage	x≤60	M16	14	330	300	—
	2-stage	x≤48	M12	10	135	250	—
	3-stage	x≤38 38 < x ≤48	M10 M12	8 10	79 135	250	—

Tbl-12: Specifications for mounting onto a motor

9.2 Specifications on mounting on the gear output side

Thread in output flange			
Gearhead size / Design TP ⁺	Bore Ø [mm]	Quantity x Thread x Depth [] x [mm] x [mm]	Tightening torque [Nm] Property class 12.9
004 MF	31.5	8 x M5 x 7	9
010 MF	50	8 x M6 x 10	15.4
025 MF	63	12 x M6 x 12	15.4
050 MF	80	12 x M8 x 15	37.3
110 MF	125	12 x M10 x 20	73.4
300 MF	140	12 x M16 x 31	310
500 MF	160	12 x M20 x 31	604
010 MA	50	12 x M6 x 10	15.4
025 MA	63	12 x M8 x 12	37.3
050 MA	80	12 x M10 x 15	73.4
110 MA	125	12 x M12 x 19	126
300 MA	145	12 x M20 x 31	604
500 MA	166	12 x M24 x 37	1042
MA = HIGH TORQUE			

Tbl-13: Specifications on mounting on the gear output side

9.3 Specifications on mounting onto a machine

Through-holes in gearhead housing				
Gearhead size / Design TP ⁺	Bore Ø [mm]	Quantity x diameter [] x [mm]	For screw size / property class	Tightening torque [Nm]
004 MF	79	8 x 4.5	M4 / 12.9	4.55
010 MF	109	8 x 5.5	M5 / 12.9	9
025 MF	135	8 x 5.5	M5 / 12.9	9
050 MF	168	12 x 6.6	M6 / 12.9	15.4
110 MF	233	12 x 9.0	M8 / 12.9	37.3
300 MF	280	16 x 13.5	M12 / 12.9	126
500 MF	310	16 x 13.5	M12 / 12.9	126
MA = HIGH TORQUE				
010 MA	109	16 x 5.5	M5 / 12.9	9
025 MA	135	16 x 5.5	M5 / 12.9	9
050 MA	168	24 x 6.6	M6 / 12.9	15.4
110 MA	233	24 x 9.0	M8 / 12.9	37.3
300 MA	280	32 x 13.5	M12 / 12.9	126
500 MA	285	32 x 13.5	M12 / 12.9	126

Tbl-14: Specifications on mounting onto a machine

9.4 Tightening torques for common thread sizes in general mechanical engineering

The specified tightening torques for headless screws and nuts are calculated values and are based on the following conditions:

- Calculation in accordance with VDI 2230 (February 2003 version)
- Friction value for thread and contact surfaces $\mu=0.10$
- Exploitation of the yield stress 90%
- Torque tools type II classes A and D in accordance with ISO 6789

The settings are values rounded to usual commercial scale gradations or setting possibilities.

- Set these values **precisely** on the scale.

Property class Screw / nut	Tightening torque [Nm] with thread												
	M3	M4	M5	M6	M8	M10	M12	M14	M16	M18	M20	M22	M24
8.8 / 8	1.15	2.64	5.2	9.0	21.5	42.5	73.5	118	180	258	362	495	625
10.9 / 10	1.68	3.88	7.6	13.2	32.0	62.5	108	173	264	368	520	700	890
12.9 / 12	1.97	4.55	9.0	15.4	37.5	73.5	126	202	310	430	605	820	1040

Tbl-15: Tightening torques for headless screws and nuts



alpha

WITTENSTEIN alpha GmbH · Walter-Wittenstein-Straße 1 · 97999 Igersheim · Germany
Tel. +49 7931 493-12900 · info@wittenstein.de

WITTENSTEIN - one with the future

www.wittenstein-alpha.de