

SP⁺

Operating Manual

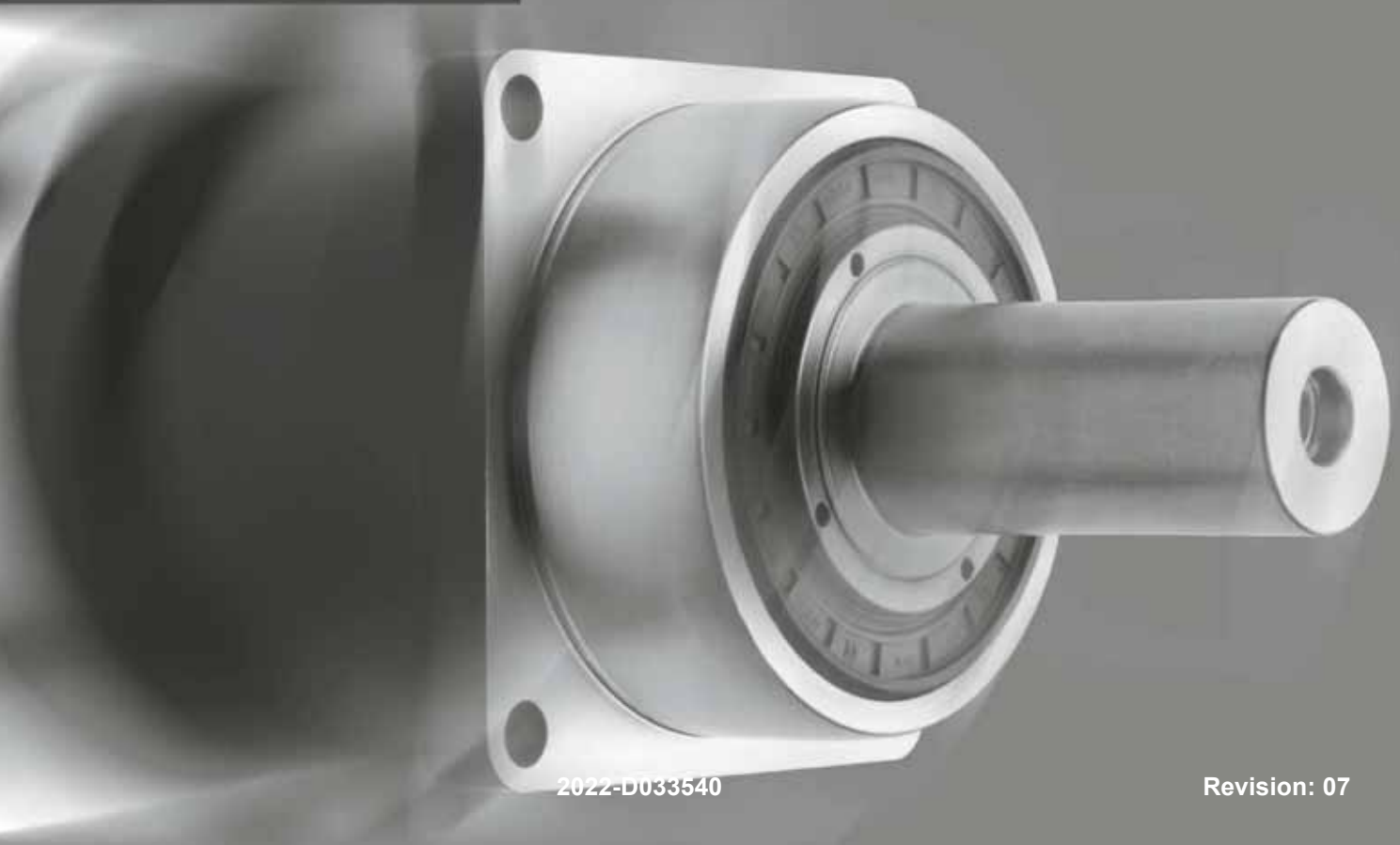

Revision history

| Revision | Date | Comment | Chapter |
|----------|----------|---|---------------|
| 01 | 07.05.09 | New version | All |
| 02 | 01.08.09 | Machinery Directive | 1, 2, 3, 4, 6 |
| 03 | 13.07.10 | Technical Data | 5.4.1 |
| 04 | 22.03.12 | Safety | All |
| 05 | 16.05.13 | Shrink disk | 2.7, 5.4 |
| 06 | 12.03.14 | Clamping hub | All |
| 07 | 23.05.16 | Adapter plate, clamping hub diameter | 5.1, 5.2, 9.1 |

Service

In case you have technical questions,
please contact:

WITTENSTEIN alpha GmbH

Customer Service
Walter-Wittenstein-Straße 1
D-97999 Igersheim

Tel.: +49 7931 493-12900

Fax: +49 7931 493-10903

E-mail: service-alpha@wittenstein.de



Motor mounting video

© WITTENSTEIN alpha GmbH 2016

This documentation is copyright protected.

WITTENSTEIN alpha GmbH reserves all the rights to photo-mechanical reproduction, copying, and the distribution by special processes (such as computers, file media, data networks), even in parts.

Subject to technical and content changes without notice.

Contents

| | | |
|----------|--|-----------|
| 1 | About this manual | 2 |
| 1.1 | Signal words | 2 |
| 1.2 | Safety symbols | 3 |
| 1.3 | Design of the safety instructions | 3 |
| 1.4 | Information symbols | 3 |
| 2 | Safety | 4 |
| 2.1 | EC directives | 4 |
| 2.1.1 | Machinery directive | 4 |
| 2.1.2 | RoHS | 4 |
| 2.2 | Dangers | 4 |
| 2.3 | Personnel | 4 |
| 2.4 | Intended use | 4 |
| 2.5 | Reasonably foreseeable misuse | 4 |
| 2.6 | Guarantee and liability | 5 |
| 2.7 | General safety instructions | 5 |
| 3 | Description of the gearhead | 7 |
| 3.1 | Overview of the gearhead components | 7 |
| 3.2 | Type plate | 8 |
| 3.3 | Ordering code | 8 |
| 3.4 | Performance data | 8 |
| 3.5 | Weight | 9 |
| 3.6 | Noise emission | 9 |
| 4 | Transport and storage | 10 |
| 4.1 | Scope of delivery | 10 |
| 4.2 | Packaging | 10 |
| 4.3 | Transport | 10 |
| 4.3.1 | Transport of gearheads up to and including size SP ⁺ 140 | 10 |
| 4.3.2 | Transport of gearheads as of size SP ⁺ 180 | 10 |
| 4.4 | Storage | 10 |
| 5 | Assembly | 11 |
| 5.1 | Preparations | 11 |
| 5.2 | Mounting the motor onto the gearhead | 12 |
| 5.3 | Mounting the gearhead to a machine | 13 |
| 5.4 | Components fastened to gear output side | 14 |
| 5.4.1 | Mounting on the slip-on shaft with shrink disk | 14 |
| 5.4.2 | Installing the shrink disk | 16 |
| 6 | Startup and operation | 17 |
| 7 | Maintenance and disposal | 17 |
| 7.1 | Maintenance work | 17 |
| 7.1.1 | Visual inspection | 17 |
| 7.1.2 | Checking the tightening torques | 17 |
| 7.2 | Startup after maintenance work | 18 |
| 7.3 | Maintenance schedule | 18 |
| 7.4 | Notes on the lubricant used | 18 |
| 7.5 | Disposal | 18 |
| 8 | Malfunctions | 19 |
| 9 | Appendix | 20 |
| 9.1 | Specifications for mounting onto a motor | 20 |
| 9.2 | Specifications for mounting onto a machine | 21 |
| 9.3 | Specifications on mounting on the gear output side | 21 |
| 9.4 | Tightening torques for common thread sizes in general mechanical engineering | 22 |

1 About this manual

These instructions contains necessary information for the safe operation of the planetary gearhead SP⁺, referred to as gearhead in the following.

If this manual is supplied with an amendment (e.g. for special applications), then the information in the amendment is valid. Contradictory specifications in this manual thereby become obsolete.

The operator must ensure that these instructions are read through by all persons assigned to install, operate, or maintain the gearhead, and that they fully comprehend them.

Store these instructions within reach of the gearhead.

These **safety instructions** should be shared with colleagues working in the vicinity of the device to ensure individual safety.

The original instructions were prepared in German; all other language versions are translations of these instructions.

1.1 Signal words

The following signal words are used to bring your attention to dangers, prohibitions, and important information:

| | |
|--|---|
| | <p style="text-align: center;">⚠ DANGER</p> <p>This signal word points to an imminent danger that can cause serious injuries and even death.</p> |
| | <p style="text-align: center;">⚠ WARNING</p> <p>This signal word points to a possible danger that can cause serious injuries and even death.</p> |
| | <p style="text-align: center;">⚠ CAUTION</p> <p>This signal word points to a possible danger that can cause slight to serious injuries.</p> |
| | <p style="text-align: center;">NOTICE</p> <p>This signal word points to a possible danger that can cause material damage.</p> |
| | <p>A note without signal word draws your attention to application tips or especially important information when handling the gearhead.</p> |

1.2 Safety symbols

The following safety symbols are used to bring your attention to dangers, prohibitions, and important information:



General danger



Hot surface



Suspended loads



Danger of being pulled in



Environment protection



Information

1.3 Design of the safety instructions

The safety instructions of these instructions are designed according to the following pattern:

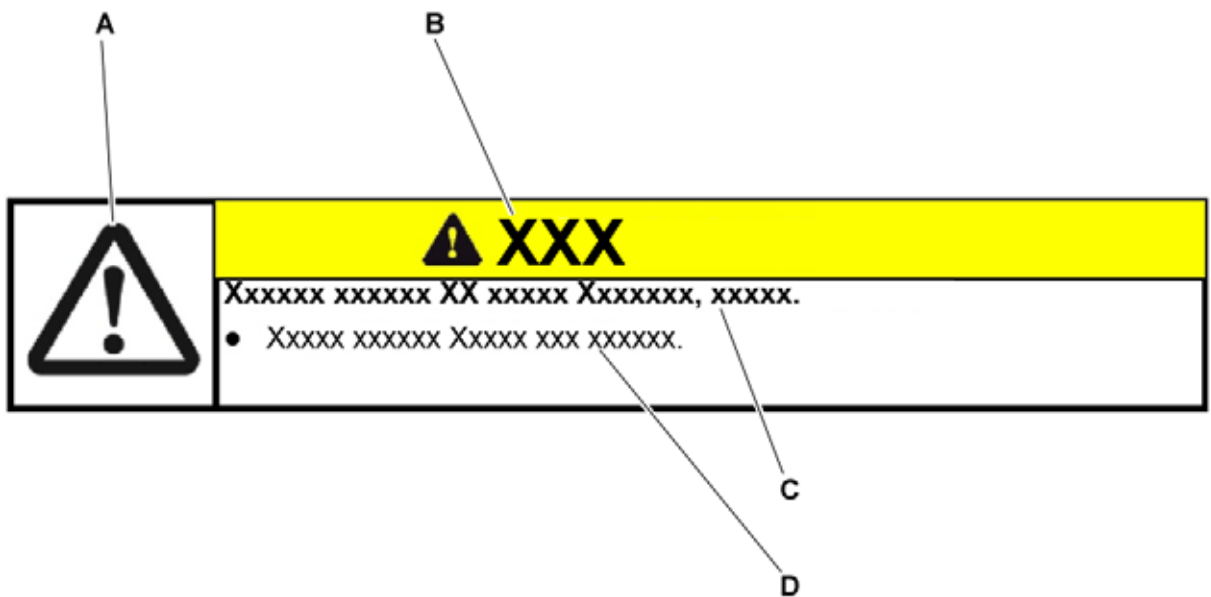

A = Safety symbol (see Chapter 1.2 "Safety symbols")

B = Signal word (see Chapter 1.1 "Signal words")

C = Type and consequence of the danger

D = Prevention of the danger

1.4 Information symbols

The following information symbols are used:

- Indicates an action to be performed
- ➡ Indicates the results of an action
- ⓘ Provides additional information on handling

2 Safety

These instructions, especially the safety instructions and the rules and regulations valid for the operating site, must be observed by all persons working with the gearhead.

In addition to the safety instructions in this manual, also observe any (legal and otherwise) applicable environmental and accident prevention rules and regulations (e.g. personal safety equipment).

2.1 EC directives

2.1.1 Machinery directive

The gearhead is considered a "machine component" and is therefore not subject to the EC Machinery Directive 2006/42/EC.

Operation is prohibited within the area of validity of the EC directive until it has been determined that the machine in which this gearhead is installed corresponds to the regulations within this directive.

2.1.2 RoHS

The homogeneous materials used in the gearhead fall below the amounts of hazardous materials limited by directive 2011/65/EU Annex II.

- Lead (0.1%)
- Mercury (0.1%)
- Cadmium (0.01%)
- Hexavalent chromium (0.1%)
- Polybrominated biphenyls (PBB) (0.1%)
- Polybrominated diphenyl ether (PBDE) (0.1%)

Installation of the gearhead therefore has no effect on the restriction of using certain hazardous materials in electrical and electronic equipment as required in the directive.

2.2 Dangers

The gearhead has been constructed according to current technological standards and accepted safety regulations.

To avoid danger to the operator or damage to the machine, the gearhead may be put to use only for its intended usage (see chapter 2.4 "Intended use") and in a technically flawless and safe state.

- Read the general safety instructions before beginning work (see Chapter 2.7 "General safety instructions").

2.3 Personnel

Only persons who have read and understood these instructions may carry out work on the gearhead.

2.4 Intended use

The gearhead serves to convert torques and speeds. It is suitable for all industrial applications.

The gearhead may not be operated in areas with explosion hazards. In food processing, the gearhead may be used only next to or under the foodstuff area.

The gearhead is intended for installation on motors that:

- Correspond to the design B5 (in the event of deviations, consult our Customer Service department [technical Customer Service department]).
- Have a radial and axial runout tolerance according to DIN EN 50347.
- Have a cylindrical shaft end with tolerance class h6 to k6.

2.5 Reasonably foreseeable misuse





Any use that deviates from the approved technical data (e.g. speed, force, torque, temperature) is not use as intended and is therefore not permitted.



2.6 Guarantee and liability

Guarantee and liability claims are excluded for personal injury and material damage in case of

- Ignoring the information on transport and storage
- Improper use (misuse)
- Improper or neglected maintenance and repair
- Improper assembly / disassembly or improper operation (e.g. test run without secure attachment)
- Operation of the gearhead when safety devices and equipment are defective
- Operation of the gearhead without lubricant
- Operation of a heavily soiled gearhead
- Modifications or reconstructions that have been carried out without the approval of **WITTENSTEIN alpha GmbH**

2.7 General safety instructions

| | |
|---|--|
|  | <p style="text-align: center;">⚠ WARNING</p> <p>Objects flung out by rotating components can cause serious injuries.</p> <ul style="list-style-type: none"> • Remove objects and tools from the gearhead before putting it into operation. • Remove/Secure the shaft key (if available) if the gearhead is operated without attachments on the output/drive side. |
|  | <p style="text-align: center;">⚠ WARNING</p> <p>Rotating components on the gearhead can pull in parts of the body and cause serious injuries and even death.</p> <ul style="list-style-type: none"> • Keep a sufficient distance to rotating machinery while the gearhead is running. • Secure the machine against restarting and unintentional movements during assembly and maintenance work (e.g. uncontrolled lowering of lifting axes). |
|  | <p style="text-align: center;">⚠ WARNING</p> <p>A damaged gearhead can cause accidents and injury.</p> <ul style="list-style-type: none"> • Never use a gearhead that has been overloaded to due misuse or a machine crash (see chapter 2.5 "Reasonably foreseeable misuse"). • Replace the affected gearhead, even if no external damage is visible. |
|  | <p style="text-align: center;">⚠ CAUTION</p> <p>Hot gearhead housing can cause serious burns.</p> <ul style="list-style-type: none"> • Touch the gearhead housing only when wearing protective gloves or after the gearhead has been at standstill for some time. |
|  | <p style="text-align: center;">NOTICE</p> <p>Loose or overloaded screw connections can damage the gearhead.</p> <ul style="list-style-type: none"> • Use a calibrated torque wrench to tighten and check all screw connections for which a tightening torque has been specified. |

| | |
|---|---|
|  | <p style="text-align: center;">⚠ WARNING</p> <p>Lubricants are flammable.</p> <ul style="list-style-type: none">• Do not spray with water to extinguish.• Suitable extinguishing agents are powder, foam, water mist, and carbon dioxide.• Observe the safety instructions of the lubricant manufacturer (see Chapter 7.4 "Notes on the lubricant used"). |
|  | <p style="text-align: center;">⚠ CAUTION</p> <p>Solvents and lubricants can cause skin irritations.</p> <ul style="list-style-type: none">• Avoid direct skin contact. |
|  | <p>Solvents and lubricants can pollute soil and water.</p> <ul style="list-style-type: none">• Use and dispose of cleaning solvents and lubricants properly. |

3 Description of the gearhead

The gearhead is a single or multi-stage low-backlash planetary gear that can be used in any mounting position. The gearhead is manufactured as standard in the following versions:

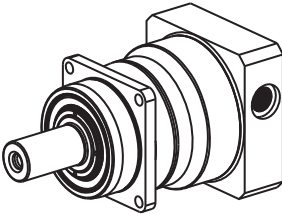
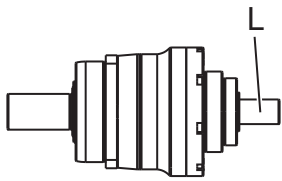
| | |
|--|--|
|  | <p>"M" (motor-mounted gearhead)</p> <p>Motor centering of the motor-mounted gearhead is performed:</p> <ul style="list-style-type: none"> - up to gearhead size SP⁺ 100 and a motor shaft diameter of 28 mm by the clamping hub (plug receptacle or coupling) - from gearhead size SP⁺ 140 and a motor shaft diameter of >28 mm by the centering collar of the motor <p>A radial distortion of the motor is avoided.</p> <p>Various types of motors can be accommodated using an adapter plate and a bushing.</p> <p>The output shaft bearing is designed to withstand high tilting moments and axial forces.</p> <p>The gearhead can be optionally equipped with a coupling to compensate for linear length compensation.</p> |
|  | <p>"S" (self-contained gearhead)</p> <p>The self-contained gearhead is based on the motor-mounted gearhead and additional mounting parts, such as drive housing and drive shaft (L). It is possible to drive the gearhead directly via the drive shaft, e.g. by means of a belt pulley.</p> <p>The drive and output shaft bearing is designed to withstand high tilting moments and axial forces.</p> |

3.1 Overview of the gearhead components

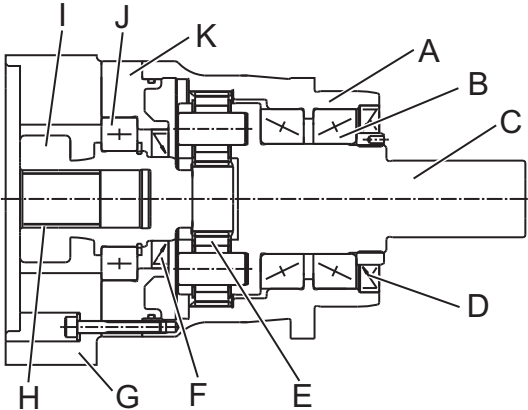
| | Gearhead components | |
|---|---------------------|---|
|  | A | Gearhead housing |
| | B | Output bearing |
| | C | Output shaft |
| | D | Radial shaft sealing ring |
| | E | Planetary gear stage |
| | F | Radial shaft sealing ring |
| | G | Adapter plate |
| | H | Bushing |
| | I | Clamping hub (plug receptacle / coupling) |
| | J | Drive bearing arrangement |
| | K | Drive housing |

Tbl-1: Overview of the gearhead components

3.2 Type plate

The type plate is attached to the gearhead housing as well input flange.

| | | Designation |
|--|---|---|
| | A | Ordering code (see Chapter 3.3 "Ordering code") |
| | B | Ratio |
| | C | Serial number |
| | D | Lubricant |
| | E | Production date |

Tbl-2: Type plate (sample values)

3.3 Ordering code

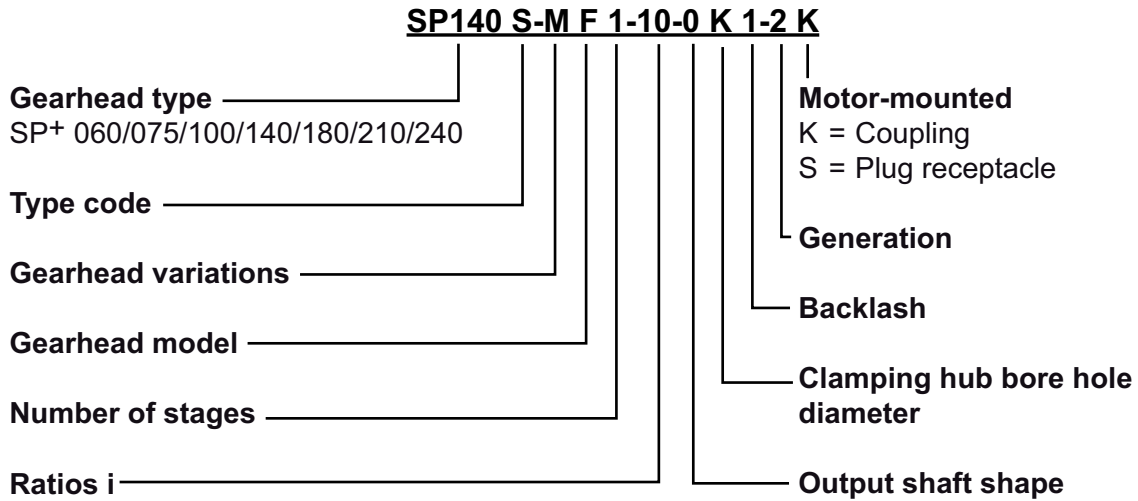

Refer to our catalog or our website at www.wittenstein-alpha.de for further information.

3.4 Performance data

For the maximum permitted speeds and torques, refer to

- our catalog,
- our website www.wittenstein-alpha.de,
- the respective customer-specific performance data (2093–D...).

| | |
|--|---|
| | <p>Consult our Customer Service department if the gearhead is older than a year. You will then receive the valid performance data.</p> |
|--|---|

3.5 Weight

The table "Tbl-3" specifies the gearhead dimensions with medium-sized adapter plate. If another adapter plate is mounted, the actual dimensions can deviate by up to 10%.

| Gearhead size SP ⁺ | | 060 | 075 | 100 | 140 | 180 | 210 | 240 |
|-------------------------------|----------|-----|-----|-----|------|------|------------|------|
| Design | Stages | | | | | | | |
| M | 1 | 1.9 | 3.9 | 7.7 | 17.2 | 34.0 | 56.0 | 77.0 |
| | 2 | 2.0 | 3.6 | 7.9 | 17.0 | 36.4 | 53.0 | 76.0 |
| S | 1 | 2.2 | 3.9 | 7.3 | 15.2 | 38.5 | on request | |
| | 2 | 2.7 | 4.1 | 9.7 | 19.3 | 38.4 | | |

Tbl-3: Weight [kg]

3.6 Noise emission

Depending on the gearhead type and product size, the continuous sound pressure level is up to 71 dB(A).

- ① For specifications on your particular product, refer to our catalogue or our Internet page at <http://www.wittenstein-alpha.de> or contact our Customer Service department.
- Observe the total noise pressure level of the machine.

4 Transport and storage

4.1 Scope of delivery

- Check the completeness of the delivery against the delivery note.
 - ① Immediately notify the carrier, the insurance company, or **WITTENSTEIN alpha GmbH** in writing of any missing parts or damage.

4.2 Packaging

The gearhead is delivered packed in foil and cardboard boxes.

- Dispose of the packaging materials at recycling sites intended for that. Observe the locally valid regulations for disposals.

4.3 Transport

| | |
|--|--|
| | <h3>⚠ WARNING</h3> |
| | <p>Suspended loads can fall and can cause serious injuries and even death.</p> <ul style="list-style-type: none"> • Do not stand under suspended loads. • Secure the gearhead before transport with suitable fasteners (e.g. belts). |
| | <h3>NOTICE</h3> |
| | <p>Hard knocks, because of falling or hard dropping, can damage the gearhead.</p> <ul style="list-style-type: none"> • Only use hoisting equipment and transports with sufficient capacity. • The maximum permitted lift capacity of a hoist may not be exceeded. • Lower the gearhead slowly. |

Specifications on the weights, refer to Chapter 3.5 "Weight".

4.3.1 Transport of gearheads up to and including size SP+ 140

No special transport mode is prescribed for transporting the gearhead.

4.3.2 Transport of gearheads as of size SP+ 180

For gearheads as of size SP+ 180, a support bore (A) is provided for a ring screw (e.g. acc. to DIN 580). The ring screw is used for attaching the gearhead securely to the hoisting equipment.

| | Gearhead size SP+ | Support bore (A) [Ø] |
|--|-------------------|----------------------|
| | 180 | M8 |
| | 210 | M10 |
| | 240 | M12 |
| | | |

Tbl-4: Support bore on the gearhead

4.4 Storage

Store the gearhead in horizontal position and dry surroundings at a temperature of 0 °C to +40 °C in the original packaging. Store the gearhead for a maximum of 2 years. Consult our Customer Service department if the conditions are different.

For storage logistics, we recommend the "first in –first out" method.

5 Assembly

- Read the general safety instructions before beginning work (see Chapter 2.7 "General safety instructions").

5.1 Preparations

| | |
|---|--|
|  | NOTICE |
| | <p>Pressurized air can damage the gearhead seals.</p> <ul style="list-style-type: none"> • Do not use pressurized air to clean the gearhead. |

| | |
|---|--|
|  | NOTICE |
| | <p>Directly sprayed cleaning agents can alter the frictional values of the clamping hub.</p> <ul style="list-style-type: none"> • Only spray cleaning agents onto a cloth for wiping off the clamping hub. |

| | |
|--|--|
| | <p>In rare situations, for a gearhead with grease lubrication, a leak can occur at the drive (seeping).</p> <p>To avoid seeping, we recommend that the surfaces between</p> <ul style="list-style-type: none"> - adapter plate and drive housing (gearhead) as well as - adapter plate and motor <p>be sealed with a surface sealing adhesive (e.g. Loctite® 573 or 574).</p> <ul style="list-style-type: none"> • For more information, please contact our Customer Service department. |
|--|--|

| | |
|---|---|
|  | NOTICE |
| | <p>Operation without an adapter plate can lead to damage.</p> <ul style="list-style-type: none"> • Only install your own adapter plate or replace an adapter plate according to the specifications of WITTENSTEIN alpha GmbH. Our customer service will provide you with disassembly instructions for this purpose. • Operation without an adapter plate is prohibited. |

- Make sure that motor meets the specifications in Chapter 2.4 "Intended use".
- Clean/de-grease and dry the following components with a clean and lint-free cloth and grease-dissolving, non-aggressive detergent:
 - All fitting surfaces to neighboring components
 - Centering
 - The motor shaft
 - The inside diameter of the clamping hub
 - The bushing inside and out
- Dry all fitting surfaces to neighboring components in order to achieve the proper friction values of the screw connections.
- Check the fitting surfaces additionally for damage and impurities.
- Select screws for fastening the motor to the adapter plate according to the motor manufacturer's specifications. Observe the minimum screw depth as determined by the property class (see Table "Tbl-5").

| Property class of the screws for fastening the motor | 8.8 | 10.9 |
|--|---------|---------|
| Minimum screw depth | 1.5 x d | 1.8 x d |
| d = Screw diameter | | |

Tbl-5: Minimum screw depth of the screws for fastening the motor to the adapter plate

5.2 Mounting the motor onto the gearhead

| | |
|--|--|
| | <ul style="list-style-type: none"> ● Observe the specifications and safety instructions of the motor manufacturer. ● Observe the safety and processing instructions for the threadlocker to be used. |
|--|--|

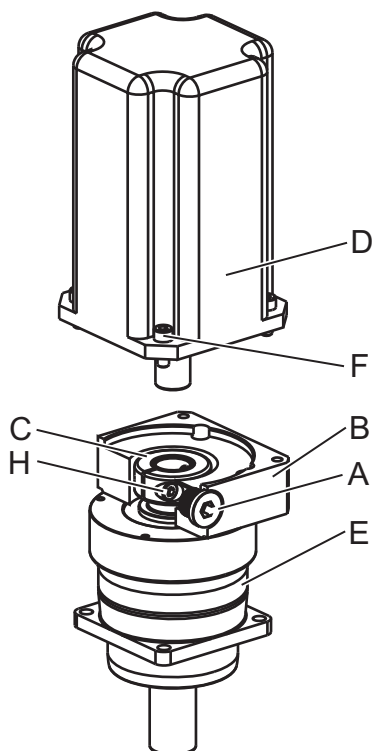

- Ensure that the motor is mounted if possible in a vertical direction.
- If the motor shaft has a shaft key, remove the shaft key.
 - ① If recommended by the motor manufacturer, insert a half wedge.
- Remove the plug (A) from the mounting bore in the adapter plate (B).
- Turn the clamping hub (C) until the clamping bolt (H) can be reached by the mounting bore.
- Loosen the clamping bolt (H) of the clamping hub (C) by one revolution.
- Push the motor shaft into the clamping hub of the gearhead (E).
 - ① The motor shaft should slip in easily. If this is not the case, the clamping bolt needs to be loosened some more.
 - ① A slotted bushing has to be additionally installed for certain motor shaft diameters and applications.
 - ① The slot of the bushing (if present) and clamping hub have to be flush with the groove (if present) of the motor shaft, see Table "Tbl-6".
 - ① No gap is permitted between motor (D) and the adapter plate (B).

| | Designation |
|--|--|
| | H Clamping bolt |
| | I Clamping ring [part of the clamping hub (C)] |
| | J Bushing |
| | K Keyed motor shaft |
| | L Smooth motor shaft |

Tbl-6: Arrangement of motor shaft, clamping hub, and bushing

① Motor centering of the motor-mounted gearhead is performed:

- up to gearhead size SP+ 100 and a motor shaft diameter of 28 mm by the clamping hub (plug receptacle or coupling)
- from gearhead size SP+ 140 and a motor shaft diameter of >28 mm by the centering collar of the motor
- Smear threadlocker (e.g. Loctite® 243) onto the four screws (F).
- Fasten the motor (D) onto the adapter plate (B) with the four screws. Evenly tighten the screws crosswise with increasing torque.
- Tighten the clamping bolt (H) of the clamping hub.
 - ① For screw sizes and prescribed tightening torques, see Chapter 9.1 "Specifications for mounting onto a motor", Table "Tbl-16".
- Screw in plug (A) of the adapter plate (B).
 - ① For the screw size and specified tightening torque, see Table "Tbl-7".

| Width across flats [mm] | 5 | 8 | 10 | 12 |
|-------------------------|----|----|----|----|
| Tightening torque [Nm] | 10 | 35 | 50 | 70 |

Tbl-7: Tightening torques for the plug

5.3 Mounting the gearhead to a machine

| | |
|--|---|
| | <ul style="list-style-type: none"> ● Observe the safety and processing instructions for the threadlocker to be used. |
|--|---|

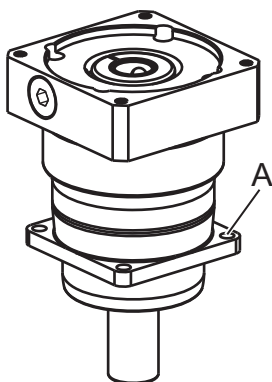

- Center the gearhead in the machine bed.
- Smear a screw-bonding agent (for example Loctite 243) onto the fastening screws.
- Fasten the gearhead on the machine with the fastening screws through the through-holes (A).
 - ① Mount the gearhead in such a way that the type plate remains legible.
 - ① Do not use washers (e.g. plain washers, tooth lock washers).
 - ① For prescribed screw sizes and torques refer to Chapter 9.2 "Specifications for mounting onto a machine", table "Tbl-17".

5.4 Components fastened to gear output side

The standard manufactured versions of the output shaft are as follows:

- Smooth output shaft
- Grooved output shaft
- Involute gearing
- Slip-on shaft
- For details on how to mount the slip-on shaft, refer to the instructions given in Chapter 5.4.1 "Mounting on the slip-on shaft with shrink disk".

| | | | | | | | |
|--|---|--|--|--|--|--|--|
| | NOTICE | | | | | | |
| | <p>Clamping forces during assembly can damage the gearhead.</p> <ul style="list-style-type: none"> • Mount the mounting parts onto the output flange without using force. • Never attempt to assemble by force or hammering! • Only use suitable tools and devices for assembly. • Make sure not to exceed the maximum permissible static axial forces on the output bearing (see Table "Tbl-8") when pulling or shrink-fitting a mounting part onto the output shaft. | | | | | | |

| Size SP ⁺ | 060 | 075 | 100 | 140 | 180 | 210 | 240 |
|----------------------|------|-------|-------|-------|-------|-------|-------|
| Fa max[N] | 9250 | 10750 | 18500 | 31250 | 49750 | 83250 | 97750 |

Tbl-8: Maximum permissible static axial forces at static load rating (s0) = 1.8 and radial force (Fr) = 0

5.4.1 Mounting on the slip-on shaft with shrink disk

The slip-on shaft has a smooth design (without keyway). The slip-on shaft is axially secured to the load shaft by means of a shrink disk connection. If a shrink disk was ordered, it has already been installed on the slip-on shaft.

- If a different shrink disk is used, observe the instructions of the manufacturer.
- ① The material of the shrink disk is specified in the article code (AC) (see Table "Tbl-10").

Depending on the material of the shrink disk, the load shaft has to meet the following conditions:

| | Material of the shrink disk | | |
|--|-----------------------------|---------------|-----------------|
| | Standard | Nickel-plated | Stainless steel |
| Minimum yield stress [N/mm²] | ≥ 385 | ≥ 260 | ≥ 260 |
| Surface roughness Rz [µm] | ≤ 16 | | |
| Tolerance | h6 | | |

Tbl-9: Features of the load shaft

| | | |
|--|--|--|
| | NOTICE | |
| | <p>Dirt can inhibit transmission of the torque.</p> <ul style="list-style-type: none"> • Do not disassemble the shrink disk prior to installation. • De-grease the load shaft and the slip-on shaft bore in the area of the shrink disk seat, leaving no residual traces. | |

- ① Only the exterior surface of the slip-on shaft may be greased in the area of the shrink disk seat.

NOTICE

The forces of the shrink disk can deform the slip-on shaft.

- Always install the load shaft first before tightening the clamping screws of the shrink disk.

- Slide the slip-on shaft onto the load shaft by hand, taking into account the minimum clamping length and the maximum permissible depth.
- ① For the minimum clamping length and the maximum permitted depth of the slip-on shaft see Chapter 9.3 "Specifications on mounting on the gear output side", Table. "Tbl-18".

NOTICE

Incorrectly aligned shafts can lead to damage.

- Ensure that the slip-on shaft is aligned with the load shaft.
- Mount the slip-on shaft onto the load shaft without using force.
- Do not on any account attempt an assembly by hammering or applying pressure.

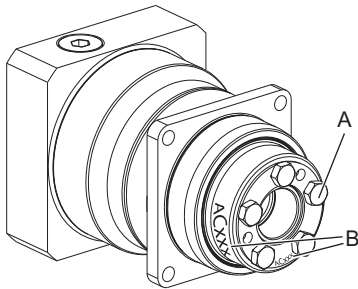

The article code (B) is located, depending on the design, on the front side or the circumference of the shrink disk.

- Refer to the article code to determine the material of the shrink disk.
- Tighten the clamping screws (A) of the shrink disk evenly distributed in multiple circular passes.
- Tighten the individual clamping screws only up to the maximum permitted tightening torque.

① For screw sizes and prescribed tightening torques, see Table "Tbl-10".

| Material of the shrink disk: Standard | | | |
|--|-------------------|-------------------|-----------------------|
| Gearhead size SP ⁺ | Article code (AC) | Tightening torque | Clamping screw thread |
| 060 | 20000744 | 12 Nm | M6 |
| 075 | 20001389 | 12 Nm | M6 |
| 100 | 20001391 | 30 Nm | M8 |
| 140 | 20001394 | 30 Nm | M8 |
| 180 | 20001396 | 30 Nm | M8 |
| Material of the shrink disk: Nickel-plated | | | |
| Gearhead size SP ⁺ | Article code (AC) | Tightening torque | Clamping screw thread |
| 060 | 20048496 | 7.5 Nm | M6 |
| 075 | 20047957 | 7.5 Nm | M6 |
| 100 | 20048497 | 34 Nm | M8 |
| 140 | 20048498 | 34 Nm | M8 |
| 180 | 20048499 | 34 Nm | M8 |

| Material of the shrink disk: Stainless steel | | | |
|--|-------------------|-------------------|-----------------------|
| Gearhead size SP+ | Article code (AC) | Tightening torque | Clamping screw thread |
| 060 | 20048491 | 7.5 Nm | M6 |
| 075 | 20043198 | 7.5 Nm | M6 |
| 100 | 20035055 | 16 Nm | M8 |
| 140 | 20047937 | 16 Nm | M8 |
| 180 | 20048492 | 16 Nm | M8 |

Tbl-10: Tightening torques for clamping screws of the supplied shrink disk

- Check that the clamping screws (A) have the maximum tightening torque, going through in sequence twice.
- ① If a separately supplied shrink disk should be installed, read the information in Chapter 5.4.2 "Installing the shrink disk".

5.4.2 Installing the shrink disk

- ① The removed shrink disk does not need to be disassembled and regreased prior to bracing it again. It is only necessary to disassemble and clean the shrink disk when it is dirty.

| | |
|--|---|
|  | NOTICE |
| | <p>Cleaned shrink disks can have another coefficient of friction. This can lead to damage during assembly.</p> <ul style="list-style-type: none"> ● Lubricate the inner smooth surfaces of the shrink disk using a solid lubricant with a coefficient of friction of $\mu = 0.04$. |

- ① The following lubricants are permitted for relubricating the shrink disk:

| Lubricant | Commercial form | Manufacturer |
|---|-----------------|--------------------|
| Molykote 321 R (lubricating varnish) | Spray | DOW Corning |
| Molykote Spray (powder spray) | Spray | DOW Corning |
| Molykote G Rapid | Spray or paste | DOW Corning |
| Aemasol MO 19 P | Spray or paste | A. C. Matthes |
| Unimoly P 5 | Powder | Klüber Lubrication |

Tbl-11: Lubricants for relubricating the shrink disk

- Push the shrink disk onto the slip-on shaft.
- ① Only the exterior surface of the slip-on shaft may be greased in the area of the shrink disk seat.
- Observe the further instructions given in Chapter 5.4.1 "Mounting on the slip-on shaft with shrink disk".

6 Startup and operation

- Read the general safety instructions before beginning work (see Chapter 2.7 "General safety instructions").

| | |
|--|---|
| | <p>Improper use can cause damage to the gearhead.</p> <ul style="list-style-type: none"> ● Make sure that <ul style="list-style-type: none"> - the ambient temperature does not drop below -15 °C or exceed $+40\text{ °C}$ and - the operating temperature does not exceed $+90\text{ °C}$. ● Avoid icing, which can damage the seals. ● For other conditions of use, consult our Customer Service department. ● Only use the gearhead only up to its maximum limit values, see Chapter 3.4 "Performance data". ● Only use the gearhead only in a clean, dust-free and dry environment. |
|--|---|

7 Maintenance and disposal

- Read the general safety instructions before beginning work (see Chapter 2.7 "General safety instructions").

7.1 Maintenance work

7.1.1 Visual inspection

- Check the entire gearhead for exterior damage.
- The radial shaft seals are subject to wear. Therefore also check the gearhead for leakage during each visual inspection.
 - ① You can find more general information on radial shaft seals on our partner's Internet site at <http://www.simrit.de>.
 - ① Check the mounting position, so that no foreign medium (e.g. oil) has collected on the output shaft.

7.1.2 Checking the tightening torques

- Check the tightening torque of the clamping bolt on the motor mounting. If you discover while checking the tightening torque that the clamping bolt can be turned further, tighten it with the prescribed tightening torque.
 - ① The prescribed tightening torques can be found in Chapter 9.1 "Specifications for mounting onto a motor", table "Tbl-16".
- Check the tightening torque of the fastening screws on the gearhead housing. If you discover while checking the tightening torque that the fastening screw can be turned further, follow the instructions at "Remounting the screw".
 - ① The prescribed tightening torques can be found in Chapter 9.2 "Specifications for mounting onto a machine", table "Tbl-17".

Remounting the screw

| | |
|--|---|
| | <ul style="list-style-type: none"> ● Make sure that it is possible to remount the screw on the gearhead without damaging the entire machine. |
|--|---|

- Loosen the screw.
- Remove the glue residue from the threaded bore and the screw.
- De-grease the screw.
- Coat the screw with a threadlocker (e.g. Loctite[®] 243).
- Screw in the screw and tighten it with the prescribed tightening torque.

7.2 Startup after maintenance work

- Clean the outside of the gearhead.
- Attach all safety devices.
- Do a trial run before releasing the gearhead again for operation.

7.3 Maintenance schedule

| Maintenance work | At startup | First time after 500 operating hours or 3 months | Every 3 months | Yearly |
|---------------------------------|------------|--|----------------|--------|
| Visual inspection | X | X | X | |
| Checking the tightening torques | X | X | | X |

Tbl-12: Maintenance schedule

7.4 Notes on the lubricant used

| | |
|---|--|
|  | <p>All gearheads are permanently lubricated by the manufacturer with synthetic gear oil (polyglycols) of viscosity class ISO VG100, ISO VG220 or with a high-performance lubricant (see type plate). All bearings are permanently lubricated by the company.</p> |
|---|--|

The manufacturer listed below will provide any further information on the lubricants:

| Standard lubricants | Lubricants for the food industry (NSF-H1 registered) |
|--|--|
| Castrol Industrie GmbH, Mönchengladbach Tel.: + 49 2161 909-30 www.castrol.com | Klüber Lubrication München KG, Munich Tel.: + 49 89 7876-0 www.klueber.com |



Tbl-13: Lubricant manufacturers

7.5 Disposal

Consult our Customer Service department for supplementary information on exchanging the adapter plate, on disassembly, and on disposal of the gearhead.

- Dispose of the gearhead at the recycling sites intended for this purpose.
 - ① Observe the locally valid regulations for disposals.

8 Malfunctions

| | |
|---|--|
|  | NOTICE |
| | <p>Changed operational behavior can be an indication of existing damage to the gearhead or cause damage to the gearhead.</p> <ul style="list-style-type: none"> Do not put the gearhead back into operation until the cause of the malfunction has been rectified. |
|  | <p>Rectifying of malfunctions may only be done by specially trained technicians.</p> |

| Fault | Possible cause | Solution |
|-----------------------------------|--|---|
| Increased operating temperature | The gearhead is not suited for the task. | Check the technical specifications. |
| | Motor is heating the gearhead. | Check the wiring of the motor. |
| | | Ensure adequate cooling. |
| | Change the motor. | |
| | Ambient temperature too high. | Ensure adequate cooling. |
| Increased noises during operation | Distortion in motor mounting | Please consult our Customer Service Department. |
| | Damaged bearings | |
| | Damaged gear teeth | |
| Loss of lubricant | Lubricant quantity too high | Wipe off discharged lubricant and continue to watch the gearhead. Lubricant discharge must stop after a short time. |
| | Seals not tight | Please consult our Customer Service Department. |

Tbl-14: Malfunctions

9 Appendix

9.1 Specifications for mounting onto a motor

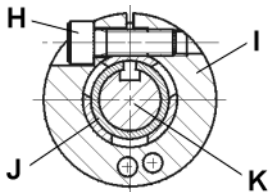
| | | Designation |
|---|---|--|
|  | H | Clamping bolt |
| | I | Clamping ring (part of the clamping hub) |
| | J | Bushing |
| | K | Motor shaft |

Tbl-15: Arrangement of motor shaft, clamping hub and bushing

| Gearhead size SP ⁺ | Clamping hub inside-Ø "x" [mm] | Clamping screw (H) / DIN ISO 4762 | Width across flats [mm] | Tightening torque [Nm] property class 12.9 | Max. axial force clamping hub [N] | | |
|----------------------------------|--------------------------------------|--|----------------------------------|---|--------------------------------------|----------|----|
| | | | | | Plug receptacle | Coupling | |
| 060 | 1-stage | $x \leq 11$ | M4 | 3 | 4.1 | 100 | 10 |
| | | $11 < x \leq 14$ | M5 | 4 | 9.5 | | |
| $14 < x \leq 19$ | | M6 | 5 | 14 | | | |
| | 2-stage | $x \leq 11$ | M4 | 3 | 4.1 | 80 | 5 |
| | | $11 < x \leq 14$ | M5 | 4 | 9.5 | | |
| 075 | 1-stage | $x \leq 14$ | M5 | 4 | 9.5 | 120 | 20 |
| | | $14 < x \leq 19$ | M6 | 5 | 14 | | |
| $19 < x \leq 24$ | | M8 | 6 | 35 | | | |
| | 2-stage | $x \leq 11$ | M4 | 3 | 4.1 | 100 | 10 |
| | | $11 < x \leq 14$ | M5 | 4 | 9.5 | | |
| | | $14 < x \leq 19$ | M6 | 5 | 14 | | |
| 100 | 1-stage | $x \leq 19$ | M6 | 5 | 14 | 150 | 30 |
| | | $19 < x \leq 24$ | M8 | 6 | 35 | | |
| $24 < x \leq 28$ | | M6 | 5 | 14 | | | |
| $28 < x \leq 38$ | | M10 | 8 | 79 | | | |
| | 2-stage | $x \leq 14$ | M5 | 4 | 9.5 | 120 | 20 |
| | | $14 < x \leq 19$ | M6 | 5 | 14 | | |
| | | $19 < x \leq 24$ | M8 | 6 | 35 | | |
| | | $24 < x \leq 28$ | M6 | 5 | 14 | | |
| 140 | 1-stage | $x \leq 24$ | M8 | 6 | 35 | 200 | 50 |
| | | $24 < x \leq 38$ | M10 | 8 | 79 | | |
| $38 < x \leq 48$ | | M12 | 10 | 135 | | | |
| | 2-stage | $x \leq 19$ | M6 | 5 | 14 | 150 | 30 |
| | | $19 < x \leq 24$ | M8 | 6 | 35 | | |
| | | $24 < x \leq 38$ | M10 | 8 | 79 | | |

| Gearhead size SP ⁺ | | Clamping hub inside-Ø "x" [mm] | Clamping screw (H) / DIN ISO 4762 | Width across flats [mm] | Tightening torque [Nm] property class 12.9 | Max. axial force clamping hub [N] | |
|-------------------------------|------------------|--------------------------------|-----------------------------------|-------------------------|--|-----------------------------------|----------|
| | | | | | | Plug receptacle | Coupling |
| 180 | 1-stage | $x \leq 38$ | M10 | 8 | 79 | 250 | 200 |
| | | $38 < x \leq 55$ | M12 | 10 | 135 | | |
| | 2-stage | $x \leq 24$ | M8 | 6 | 35 | 200 | 50 |
| | $24 < x \leq 38$ | M10 | 8 | 79 | | | |
| | $38 < x \leq 48$ | M12 | 10 | 135 | | | |
| 210 | 1-stage | $x \leq 55$ | M12 | 10 | 135 | 300 | — |
| | 2-stage | $x \leq 48$ | M12 | 10 | 135 | 250 | 200 |
| 240 | 1-stage | $x \leq 60$ | M16 | 14 | 330 | 300 | — |
| | 2-stage | $x \leq 48$ | M12 | 10 | 135 | 250 | 200 |

Tbl-16: Specifications for mounting onto a motor

9.2 Specifications for mounting onto a machine

| Gearhead size SP ⁺ | Hole-circle Ø [mm] | Bore Ø [mm] | Screw size / property class | Tightening torque [Nm] |
|-------------------------------|--------------------|-------------|-----------------------------|------------------------|
| 060 | 68 | 5.5 | M5 / 12.9 | 9 |
| 075 | 85 | 6.6 | M6 / 12.9 | 15.4 |
| 100 | 120 | 9.0 | M8 / 12.9 | 37.3 |
| 140 | 165 | 11.0 | M10 / 12.9 | 73.4 |
| 180 | 215 | 13.0 | M12 / 12.9 | 126 |
| 210 | 250 | 17.0 | M16 / 12.9 | 310 |
| 240 | 290 | 17.0 | M16 / 12.9 | 310 |

Tbl-17: Specifications for mounting onto a machine

9.3 Specifications on mounting on the gear output side

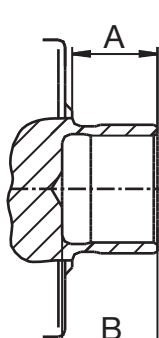
| Requirement for the slip-on shaft | | | |
|---|-------------------------------|----------------------------------|---------------------------------|
| | Gearhead size SP ⁺ | Minimum clamping length (A) [mm] | max. permissible depth (B) [mm] |
|  | 060 | 14 | 19 |
| | 075 | 16 | 21 |
| | 100 | 20 | 25 |
| | 140 | 25 | 30 |
| | 180 | 25 | 30 |
| | | | |

Tbl-18: Specifications on mounting on the gear output side

9.4 Tightening torques for common thread sizes in general mechanical engineering

The specified tightening torques for headless screws and nuts are calculated values and are based on the following conditions:

- Calculation in accordance with VDI 2230 (February 2003 version)
- Friction value for thread and contact surfaces $\mu=0.10$
- Exploitation of the yield stress 90%
- Torque tools type II classes A and D in accordance with ISO 6789

The settings are values rounded to usual commercial scale gradations or setting possibilities.

- Set these values **precisely** on the scale.

| | Tightening torque [Nm] with thread | | | | | | | | | | | | |
|-------------------------------|------------------------------------|------|-----|------|------|------|------|-----|-----|-----|-----|-----|------|
| Property class Screw / nut | M3 | M4 | M5 | M6 | M8 | M10 | M12 | M14 | M16 | M18 | M20 | M22 | M24 |
| 8.8 / 8 | 1.15 | 2.64 | 5.2 | 9.0 | 21.5 | 42.5 | 73.5 | 118 | 180 | 258 | 362 | 495 | 625 |
| 10.9 / 10 | 1.68 | 3.88 | 7.6 | 13.2 | 32.0 | 62.5 | 108 | 173 | 264 | 368 | 520 | 700 | 890 |
| 12.9 / 12 | 1.97 | 4.55 | 9.0 | 15.4 | 37.5 | 73.5 | 126 | 202 | 310 | 430 | 605 | 820 | 1040 |

Tbl-19: Tightening torques for headless screws and nuts



WITTENSTEIN alpha GmbH · Walter-Wittenstein-Straße 1 · 97999 Igersheim · Germany
Tel. +49 7931 493-12900 · info@wittenstein.de

WITTENSTEIN - one with the future

www.wittenstein-alpha.de