



WITTENSTEIN

alpha

SK⁺/SPK⁺

Operating Manual



Revision history

Revision	Date	Comment	Chapter
01	15.02.2005	New Version	All
02	17.06.2005	2-stage gearhead	All
03	15.02.2006	SPK+	All
04	31.01.2008	ANSI, Layout 07	All
05	01.07.2008	Layout WITTENSTEIN	All
06	30.01.2009	Product sizes 210, 240	3, 4, 5, 9
07	01.08.2009	Machinery Directive	1, 2, 3, 4, 6
08	10.12.2009	Technical data	5, 6, 9
09	22.12.2011	HIGH TORQUE	All
10	16.05.2013	Shrink disk	2.7, 5.4
11	19.02.2015	MRL, RoHS; safety instructions; legends	2.1; 2.7; 5.2
12	20.01.2017	Attaching the motor	5.2

Service

In case you have technical questions,
please contact:

WITTENSTEIN alpha GmbH

Customer Service
Walter-Wittenstein-Straße 1
D-97999 Igersheim

Tel.: +49 7931 493-12900

Fax: +49 7931 493-10903

E-mail: service-alpha@wittenstein.de

© WITTENSTEIN alpha GmbH 2017

This documentation is copyright protected.

WITTENSTEIN alpha GmbH reserves all the rights to photo-mechanical reproduction, copying, and the distribution by special processes (such as computers, file media, data networks), even in parts.

Subject to technical and content changes without notice..

Contents

1	About this manual	2
1.1	Signal words	2
1.2	Safety symbols	3
1.3	Design of the safety instructions	3
1.4	Information symbols	3
2	Safety	4
2.1	EC directives	4
2.1.1	Machinery directive	4
2.1.2	RoHS	4
2.2	Dangers	4
2.3	Personnel	4
2.4	Intended use	4
2.5	Reasonably foreseeable misuse	5
2.6	Guarantee and liability	5
2.7	General safety instructions	5
3	Description of the gearhead	7
3.1	Type plate	7
3.2	Ordering code	8
3.3	Performance data	8
3.4	Weight	8
3.5	Noise emission	8
4	Transport and storage	9
4.1	Scope of delivery	9
4.2	Packaging	9
4.3	Transport	9
4.3.1	Transport of gearheads up to and including size SK ⁺ /SPK ⁺ 140	9
4.3.2	Transport of gearheads as of size SK ⁺ /SPK ⁺ 180	9
4.4	Storage	10
5	Assembly	10
5.1	Preparations	10
5.2	Attaching the motor to the gearhead	11
5.3	Mounting the gearhead on a machine	12
5.4	Components mounted on the output side	12
5.4.1	Mounting on the slip-on shaft with shrink disk (SPK ⁺)	13
5.4.2	Installing the shrink disk	15
6	Startup and operation	15
7	Maintenance and disposal	16
7.1	Maintenance work	16
7.1.1	Visual inspection	16
7.1.2	Checking the tightening torques	16
7.2	Startup after maintenance work	16
7.3	Maintenance schedule	16
7.4	Notes on the lubricant used	17
7.5	Disposal	17
8	Malfunctions	18
9	Appendix	19
9.1	Specifications on mounting onto a motor	19
9.1.1	Specifications for the SK ⁺ version	19
9.1.2	Specifications for the SPK ⁺ version	20
9.2	Specifications on mounting on the gear output side (SPK ⁺)	20
9.3	Specifications for mounting on a machine	21
9.4	Tightening torques for common thread sizes in general mechanical engineering	21

1 About this manual

These instructions contain necessary information for the safe operation of the right-angle gearhead SK⁺/SPK⁺, referred to as gearhead in the following.

If this manual is supplied with an amendment (e.g. for special applications), then the information in the amendment is valid. Contradictory specifications in this manual thereby become obsolete.

The operator must ensure that these instructions are read through by all persons assigned to install, operate, or maintain the gearhead, and that they fully comprehend them.

Store these instructions within reach of the gearhead.

These **safety instructions** should be shared with colleagues working in the vicinity of the device to ensure individual safety.

The original instructions were prepared in German; all other language versions are translations of these instructions.

1.1 Signal words

The following signal words are used to indicate possible hazards, prohibitions, and important information:

	⚠ DANGER
	This signal word points out to an imminent danger that can cause serious injuries and even death.
	⚠ WARNING
	This signal word points out to a possible danger that can cause serious injuries and even death.
	⚠ CAUTION
	This signal word points out to a possible danger that can cause slight to serious injuries.
	NOTICE
	This signal word points out to a possible danger that can cause material damage.
	A note without a signal word indicates application tips or especially important information for handling the gearhead.

1.2 Safety symbols

The following safety symbols are used to bring your attention to dangers, prohibitions, and important information:



General danger



Hot surface



Suspended loads



Danger of being pulled in



Environment protection



Information

1.3 Design of the safety instructions

The safety instructions of these instructions are designed according to the following pattern:

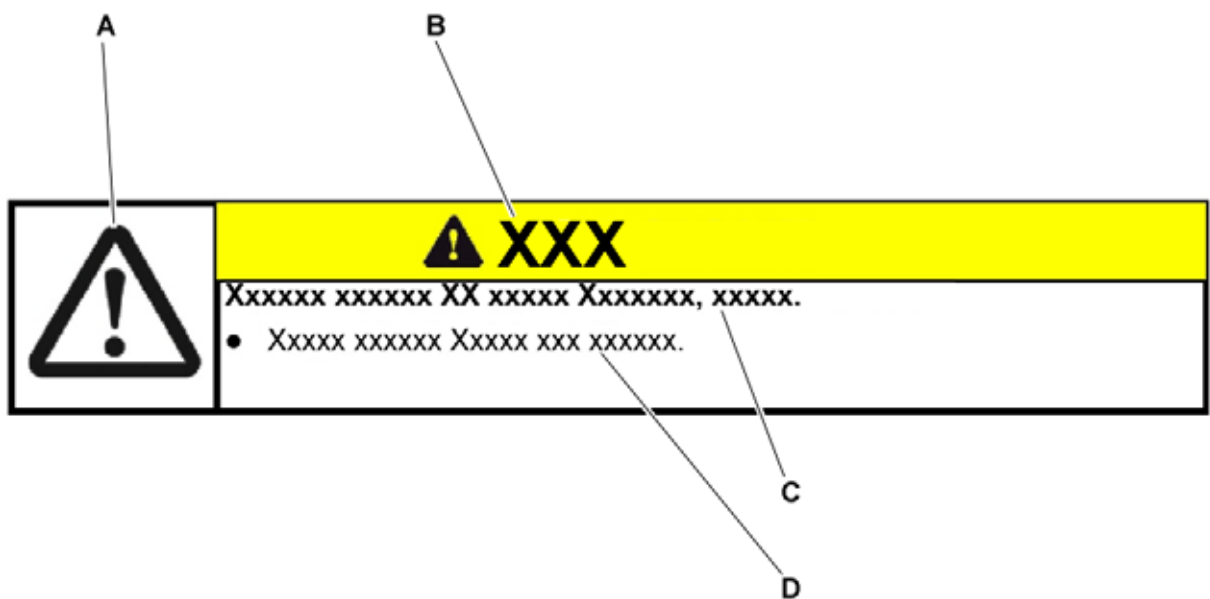

A = Safety symbol (see Chapter 1.2 "Safety symbols")

B = Signal word (see Chapter 1.1 "Signal words")

C = Type and consequence of the danger

D = Prevention of the danger

1.4 Information symbols

The following information symbols are used:

- Indicates an action to be performed
- ➞ Indicates the results of an action
- ⓘ Provides additional information on handling

2 Safety

These instructions, especially the safety instructions and the rules and regulations valid for the operating site, must be observed by all persons working with the gearhead.

In addition to the safety instructions in this manual, also observe any (legal and otherwise) applicable environmental and accident prevention rules and regulations (e.g. personal safety equipment).

2.1 EC directives

2.1.1 Machinery directive

The gearhead is considered a "machine component" and is therefore not subject to the EC Machinery Directive 2006/42/EC.

Operation is prohibited within the area of validity of the EC directive until it has been determined that the machine in which this gearhead is installed corresponds to the regulations within this directive.

2.1.2 RoHS

The homogeneous materials used in the gearhead fall below the amounts of hazardous materials limited by directive 2011/65/EU Annex II.

- Lead (0.1%)
- Mercury (0.1%)
- Cadmium (0.01%)
- Hexavalent chromium (0.1%)
- Polybrominated biphenyls (PBB) (0.1%)
- Polybrominated diphenyl ether (PBDE) (0.1%)

Installation of the gearhead therefore has no effect on the restriction of using certain hazardous materials in electrical and electronic equipment as required in the directive.

2.2 Dangers

The gearhead has been constructed according to current technological standards and accepted safety regulations.

To avoid danger to the operator or damage to the machine, the gearhead may be put to use only for its intended usage (see chapter 2.4 "Intended use") and in a technically flawless and safe state.

- Read the general safety instructions before beginning work (see Chapter 2.7 "General safety instructions").

2.3 Personnel

Only persons who have read and understood these instructions may carry out work on the gearhead.

2.4 Intended use

The gearhead serves to convert torques and speeds. It is suitable for all industrial applications.

The gearhead may not be operated in areas with explosion hazards. In food processing, the gearhead may be used only next to or under the foodstuff area.

The gearhead is intended for installation on motors that:

- Correspond to the design B5 (in the event of deviations, consult our Customer Service department [technical Customer Service department]).
- Have a radial and axial runout tolerance according to DIN EN 50347.
- Have a cylindrical shaft end with tolerance class h6 to k6.

2.5 Reasonably foreseeable misuse





Any use that deviates from the approved technical data (e.g. speed, force, torque, temperature) is not use as intended and is therefore not permitted.





2.6 Guarantee and liability

Guarantee and liability claims are excluded for personal injury and material damage in case of

- Ignoring the information on transport and storage
- Improper use (misuse)
- Improper or neglected maintenance and repair
- Improper assembly / disassembly or improper operation (e.g. test run without secure attachment)
- Operation of the gearhead when safety devices and equipment are defective
- Operation of the gearhead without lubricant
- Operation of a heavily soiled gearhead
- Modifications or reconstructions that have been carried out without the approval of **WITTENSTEIN alpha GmbH**

2.7 General safety instructions

	<p style="text-align: center;">⚠ WARNING</p> <p>Objects flung out by rotating components can cause serious injuries.</p> <ul style="list-style-type: none"> • Remove objects and tools from the gearhead before putting it into operation. • Remove/Secure the shaft key (if available) if the gearhead is operated without attachments on the output/drive side.
	<p style="text-align: center;">⚠ WARNING</p> <p>Rotating components on the gearhead can pull in parts of the body and cause serious injuries and even death.</p> <ul style="list-style-type: none"> • Keep a sufficient distance to rotating machinery while the gearhead is running. • Secure the machine against restarting and unintentional movements during assembly and maintenance work (e.g. uncontrolled lowering of lifting axes).
	<p style="text-align: center;">⚠ WARNING</p> <p>A damaged gearhead can cause accidents and injury.</p> <ul style="list-style-type: none"> • Never use a gearhead that has been overloaded to due misuse or a machine crash (see chapter 2.5 "Reasonably foreseeable misuse"). • Replace the affected gearhead, even if no external damage is visible.
	<p style="text-align: center;">⚠ CAUTION</p> <p>Hot gearhead housing can cause serious burns.</p> <ul style="list-style-type: none"> • Touch the gearhead housing only when wearing protective gloves or after the gearhead has been at standstill for some time.

	<p style="text-align: center;">NOTICE</p> <p>Loose or overloaded screw connections can damage the gearhead.</p> <ul style="list-style-type: none">• Use a calibrated torque wrench to tighten and check all screw connections for which a tightening torque has been specified.
	<p style="text-align: center;">⚠ WARNING</p> <p>Lubricants are flammable.</p> <ul style="list-style-type: none">• Do not spray with water to extinguish.• Suitable extinguishing agents are powder, foam, water mist, and carbon dioxide.• Observe the safety instructions of the lubricant manufacturer (see Chapter 7.4 "Notes on the lubricant used").
	<p style="text-align: center;">⚠ CAUTION</p> <p>Solvents and lubricants can cause skin irritations.</p> <ul style="list-style-type: none">• Avoid direct skin contact.
	<p>Solvents and lubricants can pollute soil and water.</p> <ul style="list-style-type: none">• Use and dispose of cleaning solvents and lubricants properly.

3 Description of the gearhead

The gearhead is a single- or multi-stage, low-backlash angle gear, which is manufactured as standard in the "M" version (motor installation).

Various planetary gearheads can be integrated on the drive side (SK⁺) as well as on the output side (SPK⁺).

Motor centering of the motor-mounted gearhead is performed:

- up to a motor shaft diameter of 28 mm by the clamping hub
- as of a motor shaft diameter of > 28 mm by the centering collar of the motor

A radial distortion of the motor is prevented.

Various types of motors can be accommodated using an adapter plate and a bushing.

The gearhead is equipped with an integrated linear length compensation to compensate for the expansion of the motor shaft when heated up.



The output shaft is available in the following forms:

- smooth face
- with keyway (according to DIN 6885)
- with involute (according to DIN 5480)

3.1 Type plate

The type plate is attached to the gearhead housing.

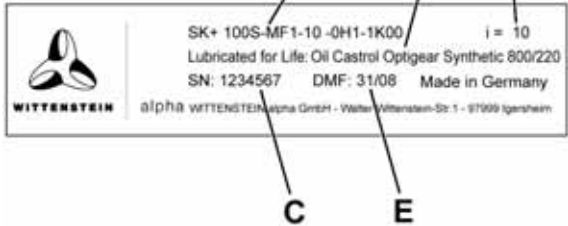
		Designation
	A	Ordering code (see Chapter 3.2 "Ordering code")
	B	Ratio
	C	Serial number
	D	Lubricant
	E	Production date

Tbl-1: Type plate (sample values)

3.2 Ordering code

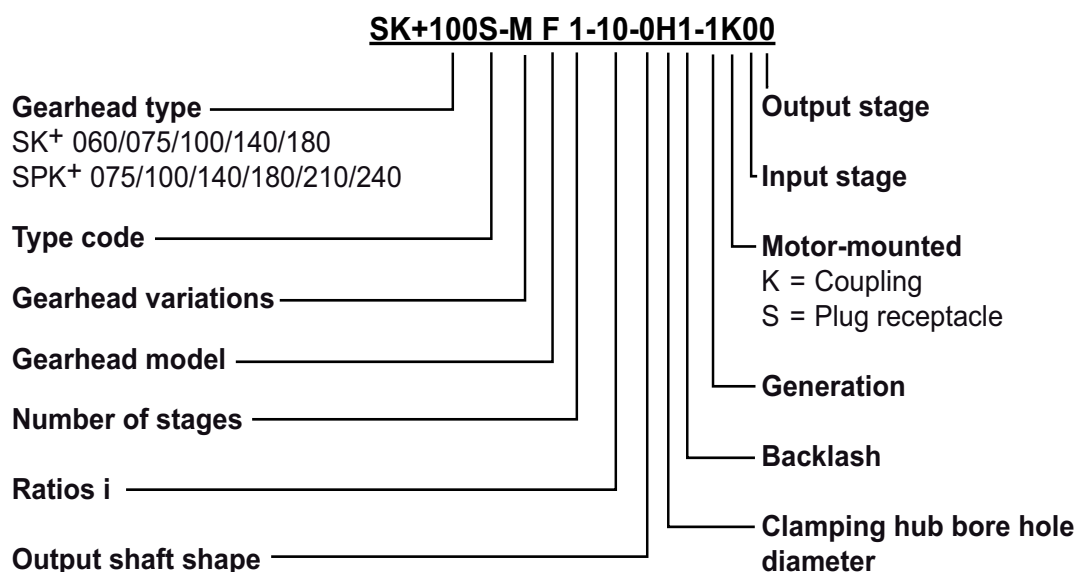

Refer to our catalog or our website at www.wittenstein-alpha.de for further information.

3.3 Performance data

For the maximum permitted speeds and torques, refer to

- our catalog,
- our website www.wittenstein-alpha.de,
- the respective customer-specific performance data (X093–D...).



Consult our Customer Service department if the gearhead is older than a year. You will then receive the valid performance data.

3.4 Weight

The table "Tbl-2" specifies the gearhead weights with a medium-sized adapter plate. If a different adapter plate is mounted, the actual weight can deviate by up to 10 %.

Gearhead size SK ⁺	060	075	100	140	180	—	—
1-stage [kg]	2.9	4.8	9.3	22.6	45.4	—	—
2-stage [kg]	3.2	5.4	10	25	48	—	—
Gearhead size SPK ⁺	—	075	100	140	180	210	240
2-stage [kg]	—	5.2	9.7	20	45	82	—
3-stage [kg]	—	5.5	10.3	20.7	47.4	86	93
4-stage [kg]	—	—	—	—	—	—	96

Tbl-2: Weight

3.5 Noise emission

Depending on the gearhead type and product size, the continuous sound pressure level is up to 75 dB(A).

- ① For specifications on your particular product, refer to our catalogue or our Internet page at <http://www.wittenstein-alpha.de> or contact our Customer Service department.
- Observe the total noise pressure level of the machine.

4 Transport and storage

4.1 Scope of delivery



- Check the completeness of the delivery against the delivery note.
 - ① Immediately notify the carrier, the insurance company, or **WITTENSTEIN alpha GmbH** in writing of any missing parts or damage.

4.2 Packaging

The gearhead is delivered packed in foil and cardboard boxes.

- Dispose of the packaging materials at recycling sites intended for that. Observe the locally valid regulations for disposals.

4.3 Transport

	<h3>⚠ WARNING</h3>
	<p>Suspended loads can fall and can cause serious injuries and even death.</p> <ul style="list-style-type: none"> • Do not stand under suspended loads. • Secure the gearhead before transport with suitable fasteners (e.g. belts).
	<h3>NOTICE</h3>
	<p>Jolts or sudden impacts as a result of falling or hard dropping. for instance, can damage the gearhead.</p> <ul style="list-style-type: none"> • Only use hoisting equipment and transports with sufficient capacity. • The maximum permitted lift capacity of a hoist may not be exceeded. • Lower the gearhead slowly.

For specifications on the weights, refer to Chapter 3.4 "Weight".

4.3.1 Transport of gearheads up to and including size SK⁺/SPK⁺ 140

No special transport mode is prescribed for transporting the gearhead.

4.3.2 Transport of gearheads as of size SK⁺/SPK⁺ 180

Gearheads from the size SK⁺/SPK⁺ 180 have support bores (A) for ring screws (e.g. according to DIN 580). The ring screws are used for attaching the gearhead securely to the hoisting equipment.

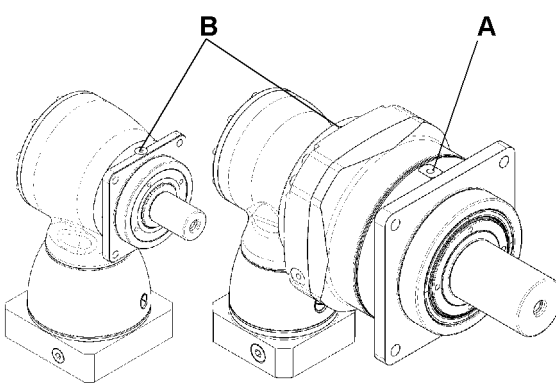
	Gearhead size SK ⁺ /SPK ⁺	Support bores (A/B) [Ø] x depth [mm]
	180	B: 1 x M8 x 14
	210	A: 1 x M10 x 17.5 B: 2 x M10 x 20
	240	A: 1 x M12 x 22 B: 2 x M10 x 18

Tbl-3: Support bores on the gearhead

4.4 Storage

Store the gearhead in horizontal position and dry surroundings at a temperature of 0 °C to +40 °C in the original packaging. Store the gearhead for a maximum of 2 years. Consult our Customer Service department if the conditions are different.

For storage logistics, we recommend the "first in –first out" method.

5 Assembly

- Read the general safety instructions before beginning work (see Chapter 2.7 "General safety instructions").

5.1 Preparations

	NOTICE
	<p>Pressurized air can damage the gearhead seals.</p> <ul style="list-style-type: none"> • Do not use pressurized air to clean the gearhead.

	NOTICE
	<p>Directly sprayed cleaning agents can alter the frictional values of the clamping hub.</p> <ul style="list-style-type: none"> • Only spray cleaning agents onto a cloth for wiping off the clamping hub.

	<p>In rare situations, for a gearhead with grease lubrication, a leak can occur at the drive (seeping).</p> <p>To avoid seeping, we recommend that the surfaces between</p> <ul style="list-style-type: none"> - adapter plate and drive housing (gearhead) as well as - adapter plate and motor <p>be sealed with a surface sealing adhesive (e.g. Loctite[®] 573 or 574).</p> <ul style="list-style-type: none"> • For more information, please contact our Customer Service department.
--	---

	NOTICE
	<p>Operation without an adapter plate can lead to damage.</p> <ul style="list-style-type: none"> • Only install your own adapter plate or replace an adapter plate according to the specifications of WITTENSTEIN alpha GmbH. Our customer service will provide you with disassembly instructions for this purpose. • Operation without an adapter plate is prohibited.

- Make sure that motor meets the specifications in Chapter 2.4 "Intended use".
- Clean/de-grease and dry the following components with a clean and lint-free cloth and grease-dissolving, non-aggressive cleaning agent:
 - All fitting surfaces to neighboring components
 - Centering
 - Motor shaft
 - The inner diameter of the clamping hub
 - The bushing, inside and out
- Dry all fitting surfaces to neighboring components in order to achieve the proper friction values of the screw connections.

- Check the fitting surfaces additionally for damage and impurities.
- Select screws for fastening the motor to the adapter plate according to the motor manufacturer's specifications. Observe the minimum screw depth as determined by the property class (see Table "Tbl-4").

Property class of the screws for fastening the motor	8.8	10.9
Minimum screw depth	1.5 x d	1.8 x d
d = Screw diameter		

Tbl-4: Minimum screw depth of the screws for fastening the motor to the adapter plate

5.2 Attaching the motor to the gearhead

	<ul style="list-style-type: none"> • Observe the specifications and safety instructions of the motor manufacturer. • Observe the safety and processing instructions for the threadlocker to be used.
--	--

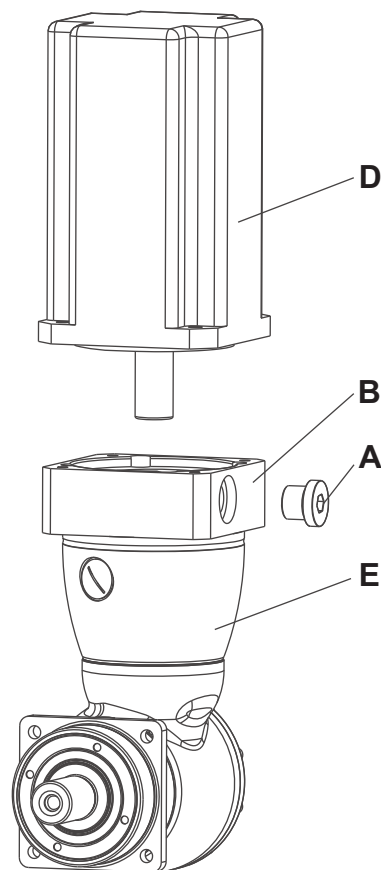

- Ensure that the motor is mounted if possible in a vertical direction.
- If the motor shaft has a shaft key, remove the shaft key.
 - ① If recommended by the motor manufacturer, apply a half key.
- Remove the plug (A) from the mounting bore in the adapter plate (B).
- Turn the clamping hub (I) until the clamping bolt (H) can be reached through the mounting bore.
- Loosen the clamping bolt (H) of the clamping hub (I) by one revolution.
- Push the motor shaft into the clamping hub of the gearhead (E).
 - ① The motor shaft should slip in easily. If this is not the case, the clamping bolt needs to be loosened some more.
 - ① A slotted bushing has to be additionally installed for certain motor shaft diameters and applications.
 - ① The slots of the bushing (if present) and clamping hub have to be aligned with the groove (if present) of the motor shaft, see Table "Tbl-5".
 - ① No gap is permitted between motor (D) and the adapter plate (B).

		Designation
	H	Clamping bolt
	I	Clamping ring (part of the clamping hub)
	J	Bushing
	K	Keyed shaft
	L	Smooth shaft

Tbl-5: Arrangement of motor shaft, clamping hub, and bushing

- ① Motor centering of the motor-mounted gearhead is performed:
 - up to a motor shaft diameter of 28 mm by the clamping hub
 - as of a motor shaft diameter of > 28 mm by the centering collar of the motor
- Coat the four bolts with a threadlocker (e.g., Loctite[®] 243).
- Fasten the motor (D) onto the adapter plate (B) with the four screws. Evenly tighten the screws crosswise with increasing torque.
- Tighten the clamping bolt (H) of the clamping hub (I).
 - ① For screw sizes and prescribed tightening torques, see Chapter 9.1 "Specifications on mounting onto a motor", Tables "Tbl-15" and "Tbl-16".
- Screw in plug (A) of the adapter plate (B).
 - ① For the screw size and specified tightening torque, see Table "Tbl-6".

Width across flats [mm]	5	8	10
Tightening torque [Nm]	10	35	50

Tbl-6: Tightening torques for the plug

5.3 Mounting the gearhead on a machine

	<ul style="list-style-type: none"> ● Observe the safety and processing instructions for the threadlocker to be used.
--	---

- Coat the fastening screws with a threadlocker (e.g. Loctite[®] 243).
- Fasten the gearhead to the machine with the fastening screws through the through-holes.
 - ① Mount the gearhead in such a way that the identification plate can still be read.
 - ① Do not use washers (e.g. plain washers, tooth lock washers).
 - ① For specified screw sizes and tightening torques, see Chapter 9.3 "Specifications for mounting on a machine", Table "Tbl-18".

5.4 Components mounted on the output side

The standard manufactured versions of the output shaft are as follows:

- Smooth output shaft
- Grooved output shaft
- Involute gearing
- Slip-on shaft (SPK⁺)
- For details on how to mount the slip-on shaft, refer to the instructions in Chapter 5.4.1 "Mounting on the slip-on shaft with shrink disk (SPK⁺)".

 NOTICE
<p>Distortions during assembly can damage the gearhead.</p> <ul style="list-style-type: none"> • Mount the mounting parts onto the output shaft without using force. • Never attempt to assemble by force or hammering! • Only use suitable tools and devices for assembly. • Make sure not to exceed the maximum permissible static axial forces on the output bearing (see Table "Tbl-7") when pulling or shrink-fitting a mounting part onto the output shaft.

Gearhead size SK ⁺ /SPK ⁺	060	075	100	140	180	210	240
Fa max [N]	9250	10750	18500	31250	49750	83250	97750

Tbl-7: Maximum permissible static axial forces at static load rating (s0) = 1.8 and radial force (Fr) = 0

5.4.1 Mounting on the slip-on shaft with shrink disk (SPK⁺)

The slip-on shaft has a smooth shape (without keyway). The slip-on shaft is axially secured to the load shaft by means of a shrink disk connection. If a shrink disk was ordered, it has already been mounted on the slip-on shaft.

- If a different shrink disk is used, observe the instructions of the manufacturer.
- ① The material of the shrink disk is specified in the article code (AC) (see Table "Tbl-9").

Depending on the material of the shrink disk, the load shaft has to meet the following conditions:

	Material of the shrink disk		
	standard	nickel-plated	stainless steel
Minimum yield stress [N/mm²]	≥ 385	≥ 260	≥ 260
Surface roughness Rz [μm]	≤ 16		
Tolerance	h6		

Tbl-8: Features of the load shaft

 NOTICE
<p>Dirt can inhibit transmission of the torque.</p> <ul style="list-style-type: none"> • Do not disassemble the shrink disk prior to installation. • De-grease the load shaft and the slip-on shaft bore in the area of the shrink disk seat, leaving no residual traces.

- ① Only the exterior surface of the slip-on shaft may be greased in the area of the shrink disk seat.

 NOTICE
<p>The forces of the shrink disk can deform the slip-on shaft.</p> <ul style="list-style-type: none"> • Always install the load shaft first before tightening the clamping screws of the shrink disk.

- Slide the slip-on shaft onto the load shaft by hand, taking into account the minimum clamping length and the maximum permissible depth.
- ① For the minimum clamping length and the maximum permissible depth of the slip-on shaft see Chapter 9.2 "Specifications on mounting on the gear output side (SPK⁺)", Table "Tbl-17".

NOTICE

Incorrectly aligned shafts can lead to damage.

- Ensure that the slip-on shaft is aligned with the load shaft.
- Mount the slip-on shaft on the load shaft without using force.
- Never attempt to assemble by hammering or applying pressure.

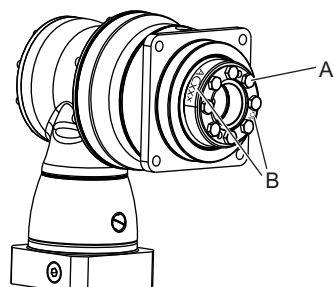

Depending on the design, the article code (B) is located either on the front side or on the circumference of the shrink disk.

- Refer to the article code to determine the material of the shrink disk.
- Tighten the clamping screws (A) of the shrink disk evenly in several sequences.
- Tighten the individual clamping screws only up to the maximum permitted tightening torque.

ⓘ For screw sizes and prescribed tightening torques, see Table "Tbl-9".

Material of the shrink disk: Standard			
Gearhead size SPK ⁺	Article code (AC)	Tightening torque	Clamping screw thread
060	20000744	12 Nm	M6
075	20001389	12 Nm	M6
100	20001391	30 Nm	M8
140	20001394	30 Nm	M8
180	20001396	30 Nm	M8
Material of the shrink disk: Nickel-plated			
Gearhead size SPK ⁺	Article code (AC)	Tightening torque	Clamping screw thread
060	20048496	7.5 Nm	M6
075	20047957	7.5 Nm	M6
100	20048497	34 Nm	M8
140	20048498	34 Nm	M8
180	20048499	34 Nm	M8
Material of the shrink disk: Stainless steel			
Gearhead size SPK ⁺	Article code (AC)	Tightening torque	Clamping screw thread
060	20048491	7.5 Nm	M6
075	20043198	7.5 Nm	M6
100	20035055	16 Nm	M8
140	20047937	16 Nm	M8
180	20048492	16 Nm	M8

Tbl-9: Tightening torques for clamping screws of the supplied shrink disk

- Check that the clamping screws (A) have the maximum tightening torque, going through in sequence twice.

- ① If a separately supplied shrink disk is to be mounted, read the information in Chapter 5.4.2 "Installing the shrink disk".

5.4.2 Installing the shrink disk

- ① The removed shrink disk does not need to be disassembled and regreased prior to bracing it again. It is only necessary to disassemble and clean the shrink disk when it is dirty.

	NOTICE
	<p>Cleaned shrink disks can have another coefficient of friction. This can lead to damage during assembly.</p> <ul style="list-style-type: none"> Lubricate the inner smooth surfaces of the shrink disk using a solid lubricant with a coefficient of friction of $\mu = 0.04$.

- ① The following lubricants are permitted for relubricating the shrink disk:

Lubricant	Commercial form	Manufacturer
Molykote 321 R (lubricating varnish)	Spray	DOW Corning
Molykote Spray (powder spray)	Spray	DOW Corning
Molykote G Rapid	Spray or paste	DOW Corning
Aemasol MO 19 P	Spray or paste	A. C. Matthes
Unimoly P 5	Powder	Klüber Lubrication

Tbl-10: Lubricants for relubricating the shrink disk

- Push the shrink disk onto the slip-on shaft.
- ① Only the exterior surface of the slip-on shaft may be greased in the area of the shrink disk seat.
- Observe the further instructions given in Chapter 5.4.1 "Mounting on the slip-on shaft with shrink disk (SPK+)".

6 Startup and operation

- Read the general safety instructions before beginning work (see Chapter 2.7 "General safety instructions").

	<p>Improper use can cause damage to the gearhead.</p> <ul style="list-style-type: none"> Make sure that <ul style="list-style-type: none"> the ambient temperature does not drop below 0 °C or exceed +40 °C and the operating temperature does not exceed +90 °C. Avoid icing, which can damage the seals. For other conditions of use, please consult our Customer Service Department. Only use the gearhead only up to its maximum limit values, see Chapter 3.3 "Performance data". Only use the gearhead only in a clean, dust-free and dry environment.
--	--

7 Maintenance and disposal

- Read the general safety instructions before beginning work (see Chapter 2.7 "General safety instructions").

7.1 Maintenance work

7.1.1 Visual inspection

- Check the entire gearhead for exterior damage.
- The radial shaft seals are subject to wear. Therefore also check the gearhead for leakage during each visual inspection.
 - ① You can find more general information on radial shaft seals on our partner's Internet site at <http://www.simrit.de>.
 - ① Check the mounting position, so that no foreign medium (e.g. oil) has collected on the output shaft.

7.1.2 Checking the tightening torques

- Check the tightening torque of the clamping bolt on the motor mounting. If, while checking the tightening torque, you discover that the screw can be turned further, tighten it to the prescribed tightening torque.
 - ① The prescribed tightening torques can be found in Chapter 9.1 "Specifications on mounting onto a motor", Tables "Tbl-15" and "Tbl-16".
- Check the tightening torque of the fastening screws on the gearhead housing. If, while checking the tightening torque, you discover that a fastening screw can be further tightened, follow the instructions in "Remounting the screw".
 - ① The prescribed tightening torques can be found in Chapter 9.3 "Specifications for mounting on a machine", Table "Tbl-18".

Remounting the screw

	<ul style="list-style-type: none"> ● Make sure that it is possible to remount the screw on the gearhead without damaging the entire machine.
--	---

- Loosen the screw.
- Remove the glue residue from the threaded bore and the screw.
- De-grease the screw.
- Coat the screw with a threadlocker (e.g. Loctite[®] 243).
- Screw in the screw and tighten it with the prescribed tightening torque.

7.2 Startup after maintenance work

- Clean the outside of the gearhead.
- Attach all safety devices.
- Do a trial run before releasing the gearhead again for operation.

7.3 Maintenance schedule

Maintenance work	At startup	For the first time after 500 operating hours or 3 months	Every 3 months	Yearly
Visual inspection	X	X	X	
Checking the tightening torques	X	X		X

Tbl-11: Maintenance schedule

7.4 Notes on the lubricant used

	All gearheads are permanently lubricated by the manufacturer with synthetic gear oil (polyglycols) of viscosity class ISO VG100, ISO VG220 or with a high-performance lubricant (see type plate). All bearings are permanently lubricated by the company.
---	---

The manufacturer listed below will provide any further information on the lubricants:

Standard lubricants	Lubricants for the food industry (NSF-H1 registered)
Castrol Industrie GmbH, Mönchengladbach Tel.: + 49 2161 909-30 www.castrol.com	Klüber Lubrication München KG, Munich Tel.: + 49 89 7876-0 www.klueber.com

Tbl-12: Lubricant manufacturers

7.5 Disposal

Consult our Customer Service department for supplementary information on exchanging the adapter plate, on disassembly, and on disposal of the gearhead.

- Dispose of the gearhead at the recycling sites intended for this purpose.
 - ① Observe the locally valid regulations for disposals.

8 Malfunctions

	NOTICE
	<p>Changed operational behavior can be an indication of existing damage to the gearhead or cause damage to the gearhead.</p> <ul style="list-style-type: none"> Do not put the gearhead back into operation until the cause of the malfunction has been rectified.

	<p>Rectifying of malfunctions may only be done by specially trained technicians.</p>
---	--

Fault	Possible cause	Solution
Increased operating temperature	The gearhead is not suited for the task.	Check the technical specifications.
	Motor is heating the gearhead.	Check the wiring of the motor.
		Ensure adequate cooling.
	Change the motor.	
Ambient temperature too high.	Ensure adequate cooling.	
Increased noises during operation	Distortion in motor mounting	Please consult our Customer Service Department.
	Damaged bearings	
	Damaged gear teeth	
Loss of lubricant	Lubricant quantity too high	Wipe off discharged lubricant and continue to watch the gearhead. Lubricant discharge must stop after a short time.
	Seals not tight	Please consult our Customer Service Department.

Tbl-13: Malfunctions

9 Appendix

9.1 Specifications on mounting onto a motor

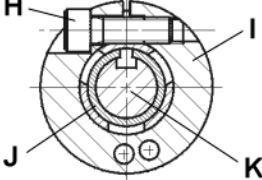
		Designation
	H	Clamping bolt
	I	Clamping ring (part of the clamping hub)
	J	Bushing
	K	shaft

Tbl-14: Arrangement of motor shaft, clamping hub and bushing

9.1.1 Specifications for the SK⁺ version

Gearhead size SK ⁺		Clamping hub interior Ø "x" [mm]	Clamping screw (H)/ property class DIN ISO 4762	Width across flats [mm]	Tightening torque [Nm]	Max. axial force clamping hub [N]	
						Plug receptacle	Coupling
060	1-stage	$x \leq 14$ $14 < x \leq 19$	M5 / 10.9 M6 / 10.9	4 5	8.5 14	—	10
	2-stage	$x \leq 11$ $11 < x \leq 14$	M4 / 12.9 M5 / 12.9	3 4	4.1 9.5	80	—
075	1-stage	$x \leq 19$ $19 < x \leq 28$	M6 / 10.9 M8 / 10.9	5 6	14 35	—	20
	2-stage	$x \leq 14$ $14 < x \leq 19$	M5 / 12.9 M6 / 12.9	4 5	9.5 14	100	—
100	1-stage	$x \leq 28$ $28 < x \leq 38$	M8 / 10.9 M10 / 10.9	6 8	35 69	—	30
	2-stage	$x \leq 19$ $19 < x \leq 28$	M6 / 12.9 M8 / 12.9	5 6	14 35	120	—
140	1-stage	$x \leq 38$	M10 / 10.9	8	69	—	50
	2-stage	$x \leq 24$ $24 < x \leq 38$	M8 / 12.9 M10 / 12.9	6 8	35 79	150	—
180	1-stage	$x \leq 48$	M12 / 10.9	10	86	—	200
	2-stage	$x \leq 38$ $38 < x \leq 48$	M10 / 12.9 M12 / 12.9	8 10	79 135	200	—

Tbl-15: Specifications for mounting on a motor

9.1.2 Specifications for the SPK⁺ version

Gearhead size SPK ⁺	Clamping hub interior Ø "x" [mm]	Clamping screw (H)/ Property class DIN ISO 4762	Width across flats [mm]	Tightening torque [Nm]	Max. axial force for clamping hub [N]	
					Plug receptacle	Coupling
075	2-stage	$x \leq 14$ $14 < x \leq 19$	M5 / 10.9 5	8.5 14	—	10
	3-stage	$x \leq 11$ $11 < x \leq 14$	M4 / 12.9 M5 / 12.9	4.1 9.5	80	—
100	2-stage	$x \leq 19$ $19 < x \leq 28$	M6 / 10.9 M8 / 10.9	14 35	—	20
	3-stage	$x \leq 14$ $14 < x \leq 19$	M5 / 12.9 M6 / 12.9	9.5 14	100	—
140	2-stage	$x \leq 28$ $28 < x \leq 38$	M8 / 10.9 M10 / 10.9	35 69	—	30
	3-stage	$x \leq 19$ $19 < x \leq 28$	M6 / 12.9 M8 / 12.9	14 35	120	—
180	2-stage	$x \leq 38$	M10 / 10.9	69	—	50
	3-stage	$x \leq 24$ $24 < x \leq 38$	M8 / 12.9 M10 / 12.9	35 79	150	—
210	2-stage	$x \leq 48$	M12 / 10.9	86	—	200
	3-stage	$x \leq 38$ $38 < x \leq 48$	M10 / 12.9 M12 / 12.9	79 135	200	—
240	3-stage	$x \leq 38$	M10 / 10.9	69	—	50
	4-stage	$x \leq 24$ $24 < x \leq 38$	M8 / 12.9 M10 / 12.9	35 79	150	—

Tbl-16: Specifications for mounting on a motor

9.2 Specifications on mounting on the gear output side (SPK⁺)

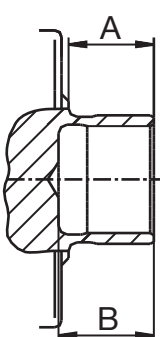
Requirement for the slip-on shaft			
	Gearhead size SPK ⁺	Minimum clamping length (A) [mm]	max. permissible depth (B) [mm]
	075	16	21
	100	20	25
	140	25	30
	180	25	30

Tbl-17: Specifications on mounting on the gear output side

9.3 Specifications for mounting on a machine

Gearhead size SK ⁺ /SPK ⁺	Hole circle Ø [mm]	Bore Ø [mm]	Screw size / Property class	Tightening torque [Nm]
060	68	5.5	M5 / 12.9	9
075	85	6.6	M6 / 12.9	15.4
100	120	9.0	M8 / 12.9	37.3
140	165	11.0	M10 / 12.9	73.4
180	215	13.5	M12 / 12.9	126
210	250	17.0	M16 / 12.9	310
240	290	17.0	M16 / 12.9	310

Tbl-18: Specifications for mounting on a machine

9.4 Tightening torques for common thread sizes in general mechanical engineering

The specified tightening torques for headless screws and nuts are calculated values and are based on the following conditions:

- Calculation in accordance with VDI 2230 (February 2003 version)
- Friction value for thread and contact surfaces $\mu=0.10$
- Exploitation of the yield stress 90%
- Torque tools type II classes A and D in accordance with ISO 6789

The settings are values rounded to usual commercial scale gradations or setting possibilities.

- Set these values **precisely** on the scale.

Property class Screw / nut	Tightening torque [Nm] with thread												
	M3	M4	M5	M6	M8	M10	M12	M14	M16	M18	M20	M22	M24
8.8 / 8	1.15	2.64	5.2	9.0	21.5	42.5	73.5	118	180	258	362	495	625
10.9 / 10	1.68	3.88	7.6	13.2	32.0	62.5	108	173	264	368	520	700	890
12.9 / 12	1.97	4.55	9.0	15.4	37.5	73.5	126	202	310	430	605	820	1040

Tbl-19: Tightening torques for headless screws and nuts



WITTENSTEIN alpha GmbH · Walter-Wittenstein-Straße 1 · 97999 Igersheim · Germany
Tel. +49 7931 493-12900 · info@wittenstein.de

WITTENSTEIN - one with the future

www.wittenstein-alpha.de