

Operating Manual

alpha Advanced Line TK⁺ ATEX



WITTENSTEIN alpha GmbH

Walter-Wittenstein-Straße 1
D-97999 Igersheim
Germany

Customer Service department

		✉)
Deutschland	WITTENSTEIN alpha GmbH	service@wittenstein.de	+49 7931 493-12900
Benelux	WITTENSTEIN BVBA	service@wittenstein.biz	+32 9 326 73 80
Brasil	WITTENSTEIN do Brasil	vendas@wittenstein.com.br	+55 15 3411 6454
中国	威騰斯坦（杭州）实业有限公司	service@wittenstein.cn	+86 571 8869 5856
Österreich	WITTENSTEIN GmbH	office@wittenstein.at	+43 2256 65632-0
Danmark	WITTENSTEIN AB	info@wittenstein.dk	+45 4027 4151
France	WITTENSTEIN sarl	info@wittenstein.fr	+33 134 17 90 95
Great Britain	WITTENSTEIN Ltd.	sales.uk@wittenstein.co.uk	+44 1782 286 427
Italia	WITTENSTEIN S.P.A.	customerservice@wittenstein.it	+39 02 241357-1
日本	ヴィッテンシュタイン株式会社	sales@wittenstein.jp	+81-3-6680-2835
North America	WITTENSTEIN holding Corp.	technicalsupport@wittenstein-us.com	+1 630-540-5300
España	WITTENSTEIN S.L.U.	info@wittenstein.es	+34 93 479 1305
Sverige	WITTENSTEIN AB	info@wittenstein.se	+46 40-26 50 10
Schweiz	WITTENSTEIN AG Schweiz	sales@wittenstein.ch	+41 81 300 10 30
台湾	威騰斯坦有限公司	info@wittenstein.tw	+886 3 287 0191
Türkiye	WITTENSTEIN Güç Aktarma Sistemleri Tic. Ltd. Şti.	info@wittenstein.com.tr	+90 216 709 21 23

© WITTENSTEIN alpha GmbH 2024

Subject to technical and content changes without notice.

Table of Contents

1	About this manual	3
1.1	Information symbols and cross references	3
1.2	Scope of delivery	3
2	Safety	4
2.1	EC/EU Directive	4
2.1.1	Machinery Directive	4
2.1.2	EU directive for devices and protective systems in potentially explosive atmospheres.....	4
2.2	Personnel	4
2.3	Intended use	5
2.4	Reasonably foreseeable misuse	6
2.5	General safety instructions	6
2.6	Structure of warning instructions.....	7
2.6.1	Safety symbols	8
2.6.2	Signal words.....	8
3	Description of the gearbox	9
3.1	Overview of gearbox components	9
3.2	Name plate.....	10
3.2.1	ATEX marking for use in potentially explosive gas atmospheres.....	10
3.2.2	ATEX marking for use in potentially explosive dust atmospheres.....	11
3.3	Ordering code	11
3.4	Ex model	12
3.5	Dimensions and performance data	12
3.6	Dimensioning	13
3.6.1	Inspection	13
3.7	Information about the lubricant	13
4	Transport and storage	14
4.1	Packaging	14
4.2	Transport.....	14
4.2.1	Transport of gearboxes up to and including size 050.....	14
4.2.2	Transport of gearboxes starting from size 110.....	14
4.3	Storage	14
5	Assembly	15
5.1	Preparations.....	15
5.2	Installation conditions.....	16
5.3	Mounting the motor to the gearbox	16
5.4	Mounting the gearbox on a machine.....	17
5.4.1	Mounting with through-holes	18
5.4.2	Mounting with slotted holes	18
5.4.3	Mounting with threaded bores	19
5.5	Components mounted to the output side	19
5.5.1	Mounting with shrink disk	20
6	Startup and operation	21
6.1	Note the following during startup	21
6.2	Checking run-in behavior	22

7	Maintenance and disposal	23
7.1	Maintenance schedule	23
7.1.1	Further maintenance intervals	23
7.2	Maintenance work	23
7.2.1	Visual/Noise inspection	23
7.2.2	Checking the tightening torques	24
7.2.3	Checking for leakage	24
7.2.4	Replacing the gearbox	24
7.3	Startup after maintenance work	24
7.4	Disposal	24
8	Disassembly	25
8.1	Removing the components of the output side	25
8.1.1	Removing the shrink disc	25
8.2	Disassembling the gearbox with the motor from the machine	26
8.3	Disassembling the motor	26
9	Malfunctions	27
10	Appendix	28
10.1	Specifications for mounting to a motor	28
10.2	Specifications for mounting to a machine	29
10.2.1	Specifications for mounting with through-holes	29
10.3	Specifications for mounting to the output side	29
10.4	Specifications for startup and operation	30
10.4.1	Mounting position	30
10.4.2	Impermissible operating conditions	31
10.5	Tightening torques for common thread sizes in general mechanical engineering	31
10.6	Technical specifications	32
10.6.1	Technical specifications for TK ⁺ 004 for use in areas with explosion hazards	32
10.6.2	Technical specifications for TK ⁺ 010 for use in areas with explosion hazards	34
10.6.3	Technical specifications for TK ⁺ 025 for use in areas with explosion hazards	36
10.6.4	Technical specifications for TK ⁺ 050 for use in areas with explosion hazards	39
10.6.5	Technical specifications for TK ⁺ 110 for use in areas with explosion hazards	41
10.7	Declaration of Conformity	44

1 About this manual

This operating manual contains necessary information to safely operate the gearbox.

If this manual is supplied with an amendment (e.g. for special applications), then the information in the amendment is valid. Contradictory specifications in this manual thereby become void.

The operator must ensure that all persons assigned to install, operate, or maintain the gearbox have read and understood these instructions in full.

Store these instructions within reach of the gearbox.

Inform colleagues who work in the area around the machine about the **safety and warning notices** to avoid injuries.

The original instructions were prepared in German; all other language versions are translations of these instructions.

1.1 Information symbols and cross references

The following information symbols are used:

- Indicates an action to be performed
- ➔ Indicates the results of an action
- ① Provides additional information about the action

A cross reference refers to the chapter number and the header of the target section (e. g. 2.3 "Intended use").

A cross reference on a table refers to the table number (e. g. Table "Tbl-15").

1.2 Scope of delivery

- Check the completeness of the delivery against the delivery note.
 - ① Missing parts or damage must be notified immediately in writing to the carrier, the insurance company, or **WITTENSTEIN alpha GmbH**.

2 Safety

These instructions, especially the safety and warning notices and the rules and regulations valid for the operating site, must be observed by all persons working with the gearbox.

The following, especially, must be strictly adhered to:

- Observe the instructions for transport and storage.
- Use the gearbox only in accordance with its intended use.
- Carry out maintenance and repair work appropriately and professionally in conformity with the specified intervals.
- Always mount, dismantle, and operate the gearbox properly (e.g. even test run only with secure mounting).
- The manufacturer of the higher-level machine shall, in accordance with its risk assessment, install protective devices and equipment as appropriate to protect the user from the residual hazards of the gearbox. Only operate the gearbox with intact and active protective devices and equipment.
- Only operate the gearbox with the correct lubricant (type and amount).
- Prevent the gearbox from becoming extremely soiled.
- Only carry out modifications or reconstructions when these are approved in writing by the **WITTENSTEIN alpha GmbH**.

Personal injuries or material damage, or other claims arising from non-observance of these minimum requirements, are the sole responsibility of the operator.

In addition to the safety-related information in this manual, also observe any legal and otherwise applicable rules and regulations, particularly for accident prevention (e.g. personal safety equipment) and environmental protection.



An "explosion protection symbol" indicates information and requirements for handling in potentially explosive atmospheres.

2.1 EC/EU Directive

2.1.1 Machinery Directive

The gearbox is considered a "machine component" and is therefore not subject to the EC Machinery Directive 2006/42/EC.

Startup is prohibited within the scope of the EC directive until it has been determined that the machine in which this gearbox is installed corresponds to the regulations within this directive.

2.1.2 EU directive for devices and protective systems in potentially explosive atmospheres



According to Directive 2014/34/EU, the gearbox is considered a device that is installed together with other devices in a machine. A declaration of conformity for this gearbox can be found in the appendix (see Chapter 10.7 "Declaration of Conformity").

Operation is prohibited within the area of validity of the directive until it has been determined that the machine in which this product is installed corresponds to the regulations within this directive.

2.2 Personnel

Only technicians who have read and understood this operating manual may perform work on the gearbox. Based on their training and experience, technicians must be able to evaluate the tasks assigned to them, in order to recognize and avoid risks.

2.3 Intended use

The gearbox serves to convert torques and speeds. It is suitable for all industrial applications.



The gearbox can be used in the potentially explosive atmospheres defined in Chapter 3.4 "Ex model".

- Observe the instructions on the name plate and the appendix on the written certificate of conformity.

The gearbox is manufactured and certified for use in potentially explosive atmospheres in compliance with standard DIN EN ISO 80079 and the following EU Directive:

- **2014/34/EU**

- Strictly observe the restrictions on speeds and torques (see Chapter 10.6 "Technical specifications").
- Our Customer Service department (technical customer service) is available to answer any questions.

The gearbox is intended for installation on motors that:

- correspond to type B5 (in the event of deviations, consult our Customer Service department [Technical Customer Service department]).
- have a radial and axial runout tolerance according to DIN EN 50347.
- have a cylindrical shaft end with tolerance class h6 to k6.
 - ① For motor shaft diameters of 55 mm and up, m6 is also permissible.
- Feature at least the same temperature class as the gearbox (see also Chapter 3.2 "Name plate").
 - ① We recommend this temperature class and higher, because the gearbox may not be allowed to exceed the maximum permitted housing temperature under normal conditions (see chapter 10.4 "Specifications for startup and operation"). The gearbox can be heated additionally through heat connection to the motor, and thus reach a higher housing temperature. The performance of our gearbox in explosion-risk areas would therefore no longer be guaranteed.

In food processing / pharmaceutical / cosmetics, the gearbox may only be used next to or under the product area. Product-specific deviation regarding the positioning and mounting position are described in Chapter 3 "Description of the gearbox".

The gearbox has been constructed according to current technological standards and accepted safety regulations.

- To avoid danger to the operator or damage to the machine, apply the gearbox only for its intended use and in a technically flawless and safe state.
- If you notice any altered operating behavior, check the gearbox in accordance with Chapter 9 "Malfunctions".
- Read the general safety instructions before beginning to work (see Chapter 2.5 "General safety instructions").

Screw connections between gearbox and attached component such as motors have to be calculated, dimensioned, mounted, and tested according to current technological standards. Use the VDI directives VDI 2862 sheet 2 and VDI 2230 for example.

- ① The tightening torques recommended by us can be found in Chapter 10 "Appendix".

Deviating from the recommendations in Chapter 5 "Assembly", washers may be used if the material of the screw surface features a too low interface pressure.

- ① The hardness of the washer needs to match the property class of the screw.
- ① Take into account the washer for the screw calculation (joint, additional compression set, surface pressure under screw head and under washer).

2.4 Reasonably foreseeable misuse



Any use that deviates from the approved technical data (e.g. speed, force, torque, temperature, service life) is not use as intended and is therefore not permitted (also see Chapter 3.5 "Dimensions and performance data").

2.5 General safety instructions

The operation of the gearbox involves residual risks even when adhering to the intended use.

Rotating components can cause serious injuries:

- Before startup, remove objects, loose components (e.g. feather keys), and tools from the gearbox, in order to avoid danger from thrown parts.
- Keep a sufficient distance to moving machine components when the gearbox is running.
- Secure the higher-level machine against restarting and unintentional movements during assembly and maintenance work (e.g. uncontrolled lowering of lifting axes).

A **hot gearbox** can cause serious burns:

- Touch the hot gearbox only with protective gloves.

The **noise emissions** can lead to hearing damage. The continuous noise pressure level may vary according to product type and gearbox size:

- ① Information about the operating noise L_{PA} of your gearbox is available in Chapter 10.6 "Technical specifications", in the customized performance data (X093–D...) or from our Customer Service / Sales department.
- For noise protection measures, observe the total noise pressure level of the machine.

Loose or overloaded screw connections can cause damage to the gearbox:

- Always use a calibrated torque wrench to tighten and check all screw connections for which a tightening torque has been specified.

Solvents and lubricants are flammable, can cause skin irritation, and can pollute soil and water:

- In case of fire: Do not spray with water to extinguish.
 - ① Suitable extinguishing agents are powder, foam, water mist and carbon dioxide. Observe the safety instructions of the lubricant manufacturer (see Chapter 3.7 "Information about the lubricant").
- Use protective gloves to avoid direct skin contact with solvents and lubricants.
- Use and dispose of cleaning solvents and lubricants properly.

A damaged **gearbox** can cause accidents and injury:

- Immediately shut down a gearbox that has been overloaded due to misuse or a machine crash (see Chapter 2.4 "Reasonably foreseeable misuse").
- Replace the damaged gearbox, even if no external damage is visible.

Explosions can cause serious injuries and even death:

- Ensure that the gearbox is only used in those areas for which it is approved according to the name plate (see Chapter 3.2 "Name plate").
- Be certain that there is no explosive atmosphere and that no dust enters the adapter plate during assembly and maintenance.

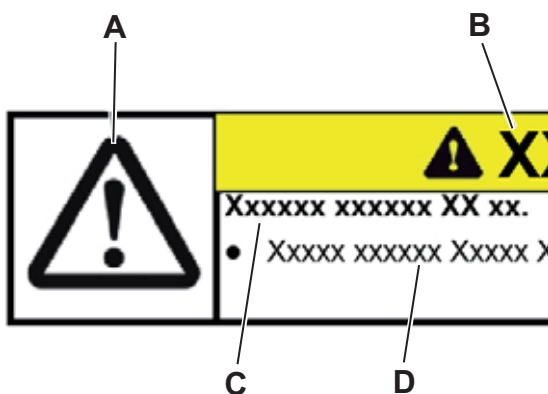

Table "Tbl-1" lists a summary of the possible hazards, their causes and protective measures for potentially explosive atmospheres.

	Dangers	Possible causes	Protective measures
	Hot surfaces	Increased friction and dissipated power because of wear, improper assembly, overload or leaks.	Reduce torques and speeds compared to standard gearboxes
			Limit the motor current and maximum speed of the motor
			Maintenance intervals for wear parts and lubricant according to maintenance schedule
			Check the temperature behavior and the run-in behavior before startup
			Regular visual and acoustic inspections
	Increased surface temperature due insulation by dust deposits.	Cleaning regulations according to maintenance plan	
Mechanically caused sparks	Overload on shafts, moving parts and connection elements.	Reduce torques and external loads compared to standard gearboxes	
		Limit the motor current of the motor	
		Perform maximum load test before startup	
Static electricity	Potential differences between components, cleaning processes, insulating layers	Ground the gearbox and the motor	

Tbl-1: Summary of the hazards and protective measures for potentially explosive atmospheres

2.6 Structure of warning instructions



Warning instructions are situation-specific. They will be precisely where tasks are described in which dangers can arise.

The warning instructions in this manual are designed according to the following pattern:

- A** = Safety symbol (see Chapter 2.6.1 "Safety symbols")
- B** = Signal word (see Chapter 2.6.2 "Signal words")
- C** = Type and consequence of the danger
- D** = Avoiding the danger

2.6.1 Safety symbols

The following safety symbols are used to indicate possible hazards, prohibitions, and important information:



General hazard



Hot surface



Suspended loads



Entanglement



Environmental protection



Information



Explosion

2.6.2 Signal words

The following signal words are used to indicate possible hazards, prohibitions, and important information:

	<p style="text-align: center;">⚠ DANGER</p> <p>This signal word indicates an imminent danger that will cause serious injuries or even death.</p>
	<p style="text-align: center;">⚠ WARNING</p> <p>This signal word indicates a potential hazard that could cause serious injuries and even death.</p>
	<p style="text-align: center;">⚠ CAUTION</p> <p>This signal word indicates a potential hazard that could cause minor or serious injuries.</p>
	<p style="text-align: center;">NOTICE</p> <p>This signal word indicates a potential hazard that could lead to material damage.</p>
	<p>A note without a signal word indicates application hints or especially important information for handling the gearbox.</p>

3 Description of the gearbox

The gearbox is a single- or multi-stage low-backlash gearbox. Certain product types may be used only in a defined mounting position.

Various types of motors can be accommodated using an adapter plate and, where necessary, a bushing.

The gearbox is equipped with an integrated linear length compensation to compensate for the expansion of the motor shaft when heated up.

3.1 Overview of gearbox components

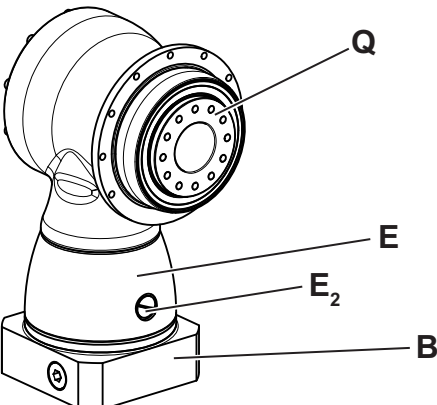
		Gearbox components
	E	Gear housing
	E ₂	Mounting opening The sealed mounting opening may not be opened.
	Q	Output flange
	B	Adapter plate

Tbl-2: Overview of gearbox components TK⁺

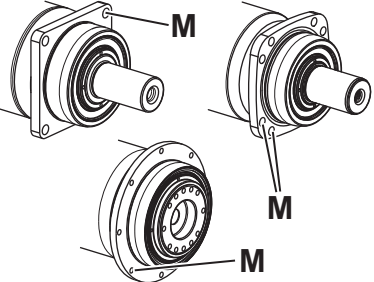
		Gearbox components
	M	Through-holes (see Chapter 5.4.1 "Mounting with through-holes")

Tbl-3: Version with through-holes

3.2 Name plate

The identification plate is attached to the gear housing or the input flange.

A	Ordering code (see Chapter 3.3 "Ordering code")	G	Production date CW/YY
B	Ratio i	H	Maximum permitted gear output torque T_{2B}
C	Lubricant	I	Maximum permitted drive speed n_{1Max}
E	ATEX marking	J	CE identification
F	Serial number	K	Manufacturer

Tbl-4: Name plate (sample values)

3.2.1 ATEX marking for use in potentially explosive gas atmospheres

		Designation
	L	Equipment category "Ex h: non-electrical"
	M	Equipment group "II: Flammable materials: gases / vapors" Subgroup "C: a typical gas is hydrogen"
	N	Temperature class "T3: Max. surface temperature $\leq 200\text{ }^{\circ}\text{C}$ "
	O	Equipment protection level (EPL) Use in zone 1: "listed ignition sources under normal operation and in the event of expected malfunctions"
	P	Restrictions regarding ambient temperature and mounting position (see Chapter 10.4 "Specifications for startup and operation")

Tbl-5: Name plate (sample values)

3.2.2 ATEX marking for use in potentially explosive dust atmospheres

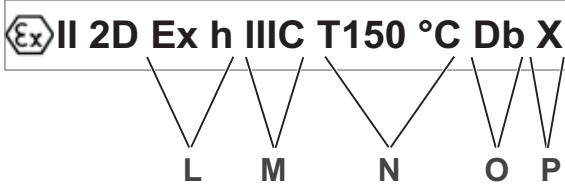
		Designation
	L	Equipment category "Ex h: non-electrical"
	M	Equipment group "III: Explosive dust atmospheres" Subgroup "C: suitable for combustible suspended solids, non-conductive and conductive dust"
	N	Max. surface temperature: 150 °C
	O	Equipment protection level (EPL) Use in zone 21: "listed ignition sources under normal operation and in the event of expected malfunctions"
	P	Restrictions regarding ambient temperature and mounting position (see Chapter 10.4 "Specifications for startup and operation")

Tbl-6: Name plate (sample values)

3.3 Ordering code

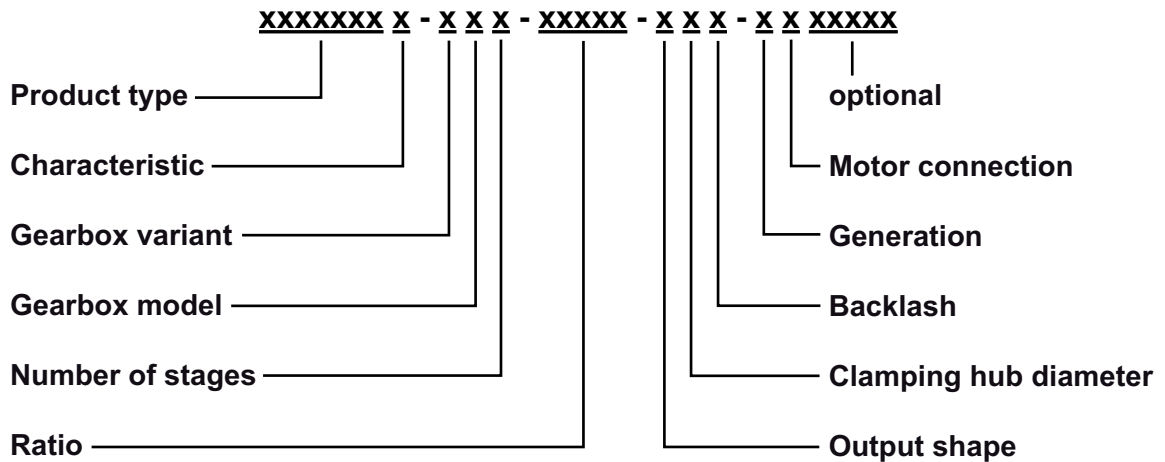

More information is available in our catalog or at www.wittenstein-alpha.de.

3.4 Ex model



The gearbox can be used in potentially explosive atmosphere group II, zones 1 and 2 as well as group III, zones 21 and 22. The gearbox can be operated in a gas atmosphere in temperature class T3. In a dust atmosphere, a maximum surface temperature of 150 °C is possible.

- Observe the instructions on the name plate and the appendix on the written certificate of conformity.

The gearbox is manufactured and certified for use in potentially explosive atmospheres in compliance with standard DIN EN ISO 80079 and EU Directive 2014/34/EU.

- Strictly observe the restrictions on speeds and torques (see Chapter 10.6 "Technical specifications").
- Observe the general safety instructions for explosion protection (see Chapter 2.5 "General safety instructions").
- Our Customer Service department is available to answer any questions.

3.5 Dimensions and performance data

Dimensions can be found

- in our catalog,
- at www.wittenstein-alpha.de,
- in the specification software **cymex**[®],
- in the respective customized performance data (X093–D...).

Performance data for gearboxes in explosive atmospheres:

Based on test results, the maximum permissible speeds and torques as well as the data on service life are reduced in relation to the standard gearbox. The shaft loads are also reduced in relation to the standard gearbox. See Chapter 10.6 "Technical specifications".

	⚠ DANGER
	<p>Deviant values can lead to explosions.</p> <ul style="list-style-type: none"> ● If the case of deviant values, please contact our Customer Service department.

3.6 Dimensioning

	⚠ DANGER
	<p>Incorrect dimensioning and inspection may lead to explosions.</p> <ul style="list-style-type: none"> • Observe all instructions in this chapter.



When ordering the gearbox, the customer must perform dimensioning in order to select the correct product. The following conditions apply to this dimensioning:

- Use the dimensioning information specified in the "Information" or "Detailed dimensioning" chapter of the general catalog, or contact **WITTENSTEIN alpha GmbH**.
- During dimensioning, note the reduced performance data in Chapter 10.6 "Technical specifications".
- Our Customer Service department is available to answer any questions.
- Note the instructions in Chapter 7.2.4 "Replacing the gearbox" if the calculated **storage life is under 20,000 h**.
- Prevent gearbox overloading by the motor by limiting motor current and motor speed.
- Clarify the chemical stability of the gearbox for every individual case so as to avoid a premature failure of a shaft seal or corrosion on the gearbox.

This also includes water and steam, which can cause corrosion. Contact **WITTENSTEIN alpha GmbH** about this.

3.6.1 Inspection



- Ensure that the connection of the motor to the gearbox corresponds to the required protection classes (according to EN 60529):
 - IP6x in dust atmospheres,
 - IP54 in gas atmospheres.

① The required protection classes can be achieved for example by the following measures:

- Use surface bonding agent between motor flange and adapter plate
(When doing so, check whether grounding is required!)
- Use sealing plates between motor flange and adapter plate to seal the through-holes of the adapter plate.

Sealing plates are available upon request from **WITTENSTEIN alpha GmbH**.

3.7 Information about the lubricant

	<p>All gearboxes are filled by the manufacturer with synthetic gear oil (polyglycols) (see name plate). Are bearings are lubricated for life at the factory.</p>
---	---

4 Transport and storage

4.1 Packaging

The gearbox is delivered packed in foil and cardboard boxes.

- Dispose of the packaging materials at the recycling sites intended for this purpose. Observe the applicable national regulations concerning disposal.

4.2 Transport

	⚠ WARNING
	<p>Suspended loads can fall and can cause serious injuries and even death.</p> <ul style="list-style-type: none"> • Do not stand under suspended loads. • Secure the gearbox before transport with suitable fasteners (e.g. belts).

	NOTICE
	<p>Impacts, for instance from falling or hard dropping, may damage the gearbox.</p> <ul style="list-style-type: none"> • Only use hoisting equipment and lifting accessories with sufficient capacity. • Never exceed the maximum permissible load for hoisting equipment. • Lower the gearbox slowly.

The table "Tbl-7" specifies the maximum gearbox weights. Depending on the version, the actual weight can be considerably less.

Gearbox size T...	004	010	025	050	110
Maximum weight [kg]	3.2	6.1	10.6	26.0	54.0

Tbl-7: Maximum weight [kg]

4.2.1 Transport of gearboxes up to and including size 050

No special method is specified for transporting the gearbox.

4.2.2 Transport of gearboxes starting from size 110

For gearboxes of size 110, we recommend the use of hoisting equipment.

4.3 Storage

Store the gearbox in horizontal position and dry surroundings at a temperature of 0 °C to +40 °C in the original packaging. Store the gearbox for a maximum of 2 years. Consult our Customer Service department if the conditions are different.

For storage logistics, we recommend the "first in - first out" method.

5 Assembly

- Read the general safety instructions before beginning to work (see Chapter 2.5 "General safety instructions").
- If you have questions about correct mounting, consult our Customer Service department.

5.1 Preparations

	NOTICE
	<p>Pressurized air can damage the gearbox seals.</p> <ul style="list-style-type: none"> • Do not use pressurized air to clean the gearbox.
	<p>Directly sprayed cleaning agents can alter the frictional values of the clamping hub.</p> <ul style="list-style-type: none"> • Only spray cleaning agents onto a cloth for wiping off the clamping hub.
	<p>Operation without an adapter plate might lead to damage.</p> <ul style="list-style-type: none"> • Operation without an adapter plate is prohibited.
	<p>In rare cases, a grease lubricated gearbox may show a small leak at the input (sweating).</p> <p>To prevent seeping, we recommend to seal the surfaces between</p> <ul style="list-style-type: none"> - adapter plate and drive housing (gearbox), as well as between - adapter plate and motor, <p>using a surface sealing adhesive (e.g. Loctite[®] 573 or 574).</p>

- Make sure that motor meets the specifications in Chapter 2.3 "Intended use".
- Select the screws for fastening the motor to the adapter plate according to the motor manufacturer's specifications. Observe the minimum screw-in depth in relation to the property class (see Table "Tbl-8").

Property class of screws for fastening the motor	8.8	10.9	Ax-70	Ax-80
Minimum screw-in depth	1.5 x d	1.8 x d	1.5 x d (*)	
d = Screw diameter				
(*) Only use a tool that is suitable for working with stainless steel.				

Tbl-8: Minimum screw-in depth of screws for fastening the motor to the adapter plate

- Clean/degrease and dry the following components using a clean and lint-free cloth, and a grease-dissolving, non-aggressive cleaning agent:
 - All fitting surfaces to neighboring components
 - Centering
 - Motor shaft
 - Inner diameter of clamping hub
 - Bushing, inside and out
- Dry all fitting surfaces to neighboring components in order to achieve the proper friction values of the screw connections.
- In addition, check the fitting surfaces for damage and impurities.

5.2 Installation conditions



- Provide a metallic frame for connection of the gearbox.
- Provide a ground in the areas of the motor gearbox and gearbox application, so as to prevent any electrostatic charge that may arise.
 - ① This will **not** ground the output shaft / output flange.

5.3 Mounting the motor to the gearbox

	<ul style="list-style-type: none"> ● Observe the specifications and safety instructions of the motor manufacturer. ● Observe the safety and processing instructions for the threadlocker to be used. ● Align the geometry of the seal surfaces before mounting the motor. ● Apply bonding agent (e. g. Loctite® 573) to avoid leaks. ● Place an appropriate sealing ring between adapter plate and motor for gearboxes in Hygienic Design to avoid leaks. ① In addition, WITTENSTEIN alpha GmbH offers a suitable sealing plate.
--	--

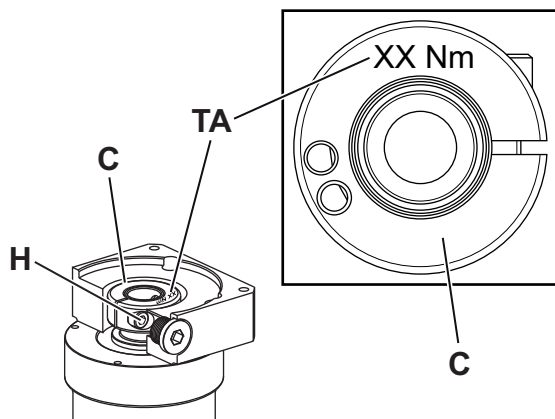

The tightening torque value [TA] of the clamping bolt [H] can be found on the clamping hub [C].

- ① The value for the tightening torque can also be found in Chapter 10.1 "Specifications for mounting to a motor".

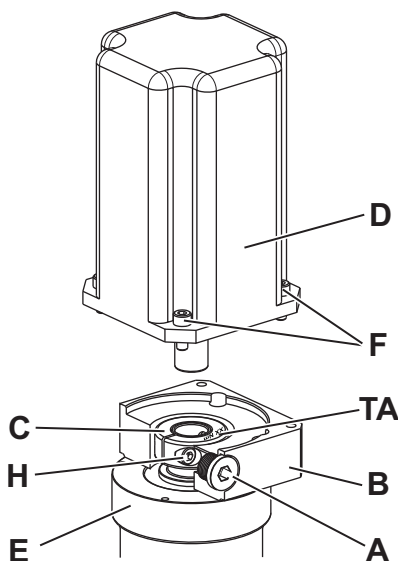

- Preferably, the motor should be mounted in a vertical orientation.
- Remove the locking screw / stopper plug [A] from the mounting bore in the adapter plate [B].
- Rotate clamping hub [C] until the clamping bolt [H] can be reached via the mounting bore.
- Loosen the clamping bolt [H] of clamping hub [C] by one revolution.
- Slide the motor shaft into the clamping hub of the gearbox [E].

- ① The motor shaft should slide in easily. If this is not the case, the clamping bolt needs to be loosened some more.

- ① If the clamping bolt [H₁] is loosened too far or removed, the clamping ring [I] can rotate on the clamping hub. Align it so that the clamping bolt [H₁] is in the keyway of the clamping hub (see table "Tbl-9").
- ① For certain motor shaft diameters and applications, a slotted bushing needs to be installed in addition.
- ① For the version with **clamping bolt, eccentric [H₁]**:
The slot of the bushing (if present) and the clamping hub must be flush with the groove (if present) of the motor shaft; see Table "Tbl-9".
For the version with **clamping bolt, central [H₂]**:
The slots of the bushing (if present) and clamping hub have to be aligned with the keyway (if present) of the motor shaft and rotated 90° from the clamping bolt, see Table "Tbl-9".
- ① No gap is permitted between the motor [D] and the adapter plate [B].

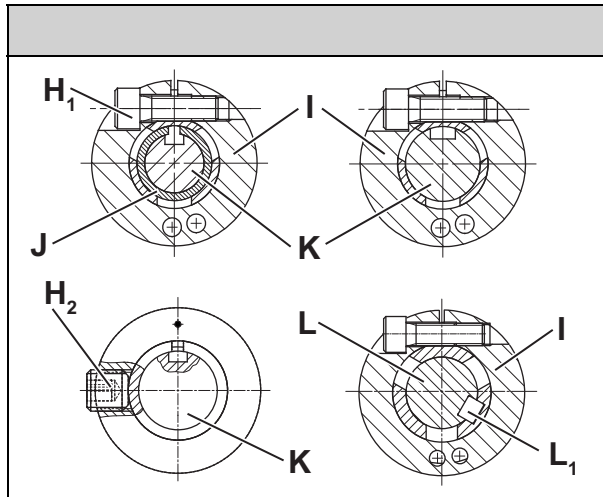
		Designation
	H ₁	Clamping bolt, eccentric
	H ₂	Clamping bolt, central
	I	Clamping ring
	J	Bushing
	K	Keyed motor shaft
	L	Motor shaft with shaft key
	L ₁	Shaft key

Tbl-9: Arrangement of motor shaft, clamping bolt and bushing

- Apply threadlocker (e. g. Loctite[®] 243) to the four screws [F].
- Fasten the motor [D] onto the adapter plate [B] with the four screws. Evenly tighten the screws crosswise with increasing torque.
- If the gearbox is a **single-stage gearbox (MF1)**, coat the clamping bolt [H] with threadlocker (such as Loctite 243).
- Tighten the clamping bolt [H] of the clamping hub [C].
 - ① The value for the tightening torque can also be found in Chapter 10.1 "Specifications for mounting to a motor".
- Screw the **locking screw** [A] into the adapter plate [B].
 - ① For screw size and specified tightening torque, see Table "Tbl-10".

Width across flats [mm]	5	8	10	12
Tightening torque [Nm]	10	35	50	70

Tbl-10: Tightening torques for the plug

5.4 Mounting the gearbox on a machine

	<ul style="list-style-type: none"> ● Observe the safety and processing instructions for the threadlocker to be used.
--	---

- Center the gearbox in the machine bed.
- Apply threadlocker (e. g. Loctite[®] 243) to the fastening screws.

- ① Mount the gearbox so that the identification plate can still be read.
- ① The specified screw sizes and tightening torques can be found in Chapter 10.2 "Specifications for mounting to a machine".
- ① If your gearbox is equipped with a liquid-cooled adapter plate, the separate manual "Cooled adapter plate" (doc. no. 2022–D063351) applies for this. The manual will be provided by our Sales / Customer Service department on request. Please always provide the serial number.
- ① **WITTENSTEIN alpha GmbH** offers corresponding mounting kits for gearboxes in **Hygienic Design**. The separate instructions "Hygienic Design Instruction Sheet, Mounting Kit" (Doc. no. 2022–D062618) are valid for this. The manual will be provided by our Sales / Customer Service department on request. Please always provide the serial number.

5.4.1 Mounting with through-holes

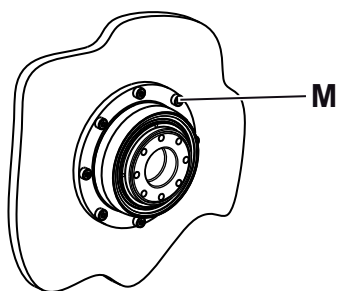

- ① If your gearbox is equipped with reverse centering for motor-side installation [M] on a machine, you will find more information in the separate manual "Reverse centering device for motor-side installation" (doc. no. 2022–D063062). The manual will be provided by our Sales / Customer Service department on request. Please always provide the serial number.

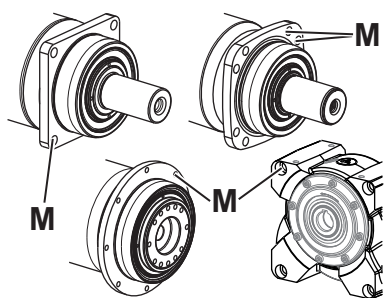

- ① We recommend doing without washers as long as the material of the screw surface features sufficient interface pressure.
- Fasten the gearbox on the machine with the fastening screws through the through-holes [M].

5.4.2 Mounting with slotted holes

- Use only the washers included with the delivery for fastening the gearbox to the machine (see Chapter 10.2 "Specifications for mounting to a machine").

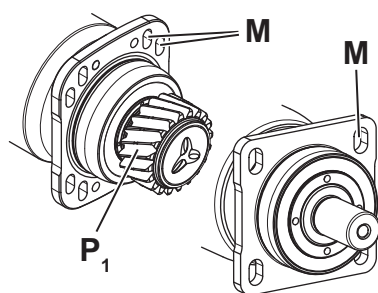

The gearbox can be optionally equipped with an output pinion [P₁]. The gearing backlash between output pinion and toothed rack/ counter-wheel can be adjusted using the slotted holes [M] and the lateral guides. An additional adjustment mechanism is no longer necessary.

- ① Detailed information on the design of the gearbox interface is available on request.
- ① For the proper setting of the gearing backlash, you will find further information in the "alpha rack and pinion system" manual (doc. no. 2022–D001333). The manual will be provided by our Sales / Customer Service department on request. Please always provide the serial number.

Operating the gearbox without a motor (e.g. using a hand wheel) is permitted for setting / aligning the output pinion on the toothed rack.

- When doing so, ensure **never** to tilt / bend the clamping hub.

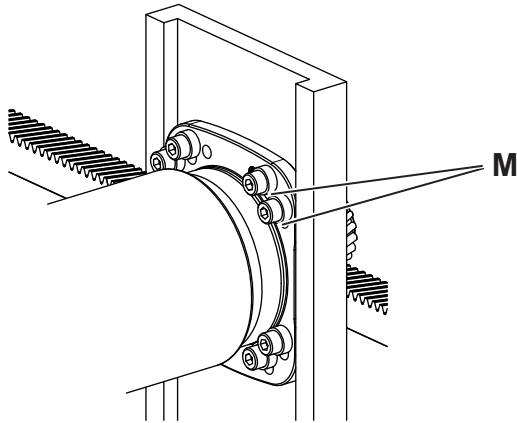

- Slide the washers onto the fastening screws.
- Fasten the gearbox to the machine with the fastening screws through the slotted holes [M].

Pinning the mounted and aligned gearbox (optional)

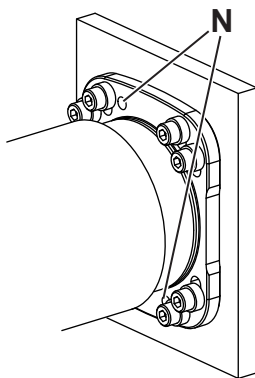

Optionally, there are two bore holes [N] on the gear housing for pinning the gearbox to the machine. You can fasten the gearbox to the machine with cylinder pins.

- Drill pin holes into the machine bed according to the bores [N] of the gear housing.
- Ream the bores to the corresponding fit size for the cylinder pins.
 - ⓘ For specifications on the cylinder pins, refer to Chapter 10.2 "Specifications for mounting to a machine".
- Fasten the gearbox with the cylinder pins.

5.4.3 Mounting with threaded bores

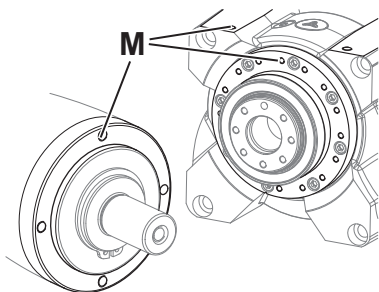

- ⓘ We recommend doing without washers as long as the material of the screw surface features sufficient interface pressure.
- Fasten the gearbox to the machine with the fastening screws through the threaded bores [M].

5.5 Components mounted to the output side

The output side has different shapes depending on the product type:

- Smooth shaft
- Shaft with shaft key
- Splined shaft (DIN 5480)
- Blind hollow shaft / hollow shaft / hollow shaft interface / flange hollow shaft
- Flange
- With mounted output pinion
- For details on how to mount the **slip-on shaft / hollow shaft / hollow shaft interface**, refer to the instructions in Chapter 5.5.1 "Mounting with shrink disk".
- For details on how to fasten the **flange / flange hollow shaft / keyed hollow shaft**, refer to the instructions in Chapter 10.3 "Specifications for mounting to the output side".

	NOTICE
<p>Tension during assembly may damage the gearbox.</p> <ul style="list-style-type: none"> ● Mount the mounting parts onto the output shaft / output flange without using force. ● Never attempt to assemble by force or hammering! ● Only use suitable tools and devices for assembly. ● Make sure not to exceed the maximum permissible static axial forces on the output bearing (see Chapter 10.3 "Specifications for mounting to the output side") when pulling or shrink-fitting a mounting part onto the output side. 	

① **WITTENSTEIN alpha GmbH** offers corresponding mounting kits for gearboxes in **Hygienic Design**. The separate instructions "Hygienic Design Instruction Sheet, Mounting Kit" (Doc. no. 2022–D062618) are valid for this. The manual will be provided by our Sales / Customer Service department on request. Please always provide the serial number.

5.5.1 Mounting with shrink disk

- 

 - Use only shrink discs provided by **WITTENSTEIN alpha GmbH** for the gearbox (also refer to the "Shrink Disc" manual (doc. no. 2022-D063039)).
 - Avoid lateral forces or bending torques acting on the blind hollow shaft / hollow shaft / hollow shaft interface (also refer to Chapter 10.4.2 "Impermissible operating conditions").

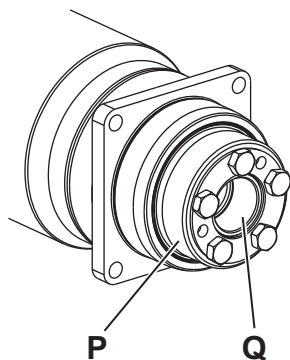

The slip-on shaft / hollow shaft / hollow shaft interface [Q] is axially secured to the load shaft by means of a shrink disk connection. If a gearbox with shrink disk [P] was ordered, then it is already mounted.

- ① With the recommended fit size h6 for the load shaft, it must be possible to push the disk on without exerting force, but without a noticeable fit tolerance. The required dimensions for the blind hollow shaft / hollow shaft are found in the catalog (see also Chapter 3.5 "Dimensions and performance data").
- ① Further important instructions on how to handle the shrink disk are found in the separate manual "Shrink disk" (doc. no. 2022–D063039). The manual will be provided by our Sales / Customer Service department on request. Please always provide the serial number.

6 Startup and operation

- Read the general safety instructions before beginning to work (see Chapter 2.5 "General safety instructions").

	⚠ DANGER
	<p>Operating the gearbox in areas for which it is not approved can lead to explosions that may cause serious injuries and even death.</p> <ul style="list-style-type: none"> • Ensure that the gearbox is only used in those areas for which it is approved according to the name plate (see Chapter 3.2 "Name plate").

- Check the gearbox before startup for possible damage, especially the radial shaft seal on the gear output.

	⚠ DANGER
	<p>A damaged gearbox can lead to explosions that can cause serious injuries and even death.</p> <ul style="list-style-type: none"> • Never operate damaged or abnormally running or sounding gearboxes in a potentially explosive area.

Improper use can cause damage to the gearbox.

- Ensure that
 - the **ambient temperature** is in the permissible range (see Chapter 10.4 "Specifications for startup and operation") and
 - the **operating temperature** does not exceed the maximum value (see Chapter 10.4 "Specifications for startup and operation").
- Avoid freezing, which can damage the seals.
- Protect the gearbox from atmospheric influences.
- Use the gearbox only in a clean and dry environment.
- Only use the gearbox up to its maximum limit values, see Chapter 3.5 "Dimensions and performance data". For other conditions of use, consult our Customer Service department.

6.1 Note the following during startup



Improper use can cause damage to the gearbox and cause ignition hazards.

- Prevent gearbox from overloading by limiting the motor current and the maximum motor speed. Otherwise, the drive output should be switched off when the motor temperature rises 10 °C above the usual operational temperature.
- Only use the gearbox in cyclic duty operation (S5).
- Use the gearbox only in a dry environment. Contact our Customer Service department if the gearbox is exposed to fluids of any type when in operation.
- Follow the instructions for startup and operation in the Chapter 10.4 "Specifications for startup and operation".

6.2 Checking run-in behavior



- Make sure there is **no** explosive atmosphere during the test.
- After 4 running hours in maximum operating conditions, check the gearbox for leakage between gear and motor and on the output shaft seal.
- Measure the surface temperature at two points on the gear housing (one near the drive and one near the output, see also Chapter 3.1 "Overview of gearbox components"). Consult with our Customer Service department if the maximum permissible housing temperature is exceeded (see chapter 10.6 "Technical specifications").
- Check the proper assembly of the clamping hub before startup by a maximum load test. Increased running noises may be caused by faulty motor mounting.
- If so, mount onto motor again according to the operating manual, or consult our Customer Service department.

7 Maintenance and disposal

- Read the general safety instructions before beginning to work (see Chapter 2.5 "General safety instructions").
- Secure the higher-level machine against restarting and unintentional movements during assembly and maintenance work (e.g. uncontrolled lowering of lifting axes).

7.1 Maintenance schedule

Maintenance work	At startup	After running-in (4 hours)	After every 500 operating hours or 3 months
Visual/Noise inspection	X	X	X
Checking the tightening torques	X	X	X
Checking for leakage	X	X	X
Chapter 6.2 "Checking run-in behavior"	-	X	-
Replacing the gearbox after reaching 90% of the calculated nominal bearing life, but at the latest after 20,000 operating hours.			

Tbl-11: Maintenance schedule

7.1.1 Further maintenance intervals

- Send the gearbox to **WITTENSTEIN alpha GmbH** for the following types of maintenance:
 - The radial shaft seal on the drive must be replaced and an oil change is required **every 5,000 operating hours**.
 - In addition, the radial shaft seal on the output must be replaced **every 10,000 operating hours**.

7.2 Maintenance work



The following maintenance work is crucial for the explosion protection.

- Perform these tasks thoroughly and diligently.

	⚠ DANGER
	<p>When opening up the Ermeto coupling, dust could collect on the adapter plate and catch fire during later operation.</p> <ul style="list-style-type: none"> • Ensure that no explosive dust-air mixture is present and no dust can get into adapter plate before opening the Ermeto coupling or dismantling the motor.

7.2.1 Visual/Noise inspection

- Dust off the housing. Ensure that the deposit of dust layers on the housing never exceeds a layer thickness of 5 mm.
 - Check the entire gearbox for exterior damage and corrosion.
 - Check the clamping hub for external damage when inspecting the tightening torques of the clamping bolt.
 - Check the gearbox for unusual running noises and vibrations during operation.
- ① For special information on maintenance-related issues, contact our Customer Service department.

7.2.2 Checking the tightening torques

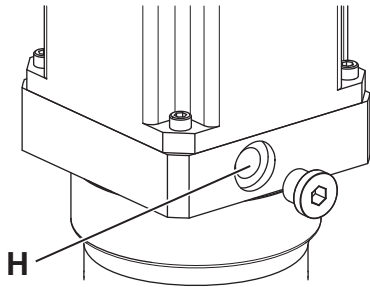

- Check the tightening torque of the clamping bolt [H] on the motor mounting. If, while checking the tightening torque, you discover that the clamping bolt can be turned further, tighten it to the prescribed tightening torque.
- ① The value for the tightening torque can also be found in Chapter 10.1 "Specifications for mounting to a motor".

Screw connections between gearbox and attached component such as motors have to be calculated, dimensioned, mounted, and tested according to current technological standards. Use the VDI directives VDI 2862 sheet 2 and VDI 2230 for example.

① The tightening torques recommended by us can be found in Chapter 10 "Appendix".

Deviating from the recommendations in Chapter 5 "Assembly", washers may be used if the material of the screw surface features a too low interface pressure.

- ① The hardness of the washer needs to match the property class of the screw.
- ① Take into account the washer for the screw calculation (joint, additional compression set, surface pressure under screw head and under washer).

7.2.3 Checking for leakage

- Check the gear output radial shaft seal for leakage.
- Look for external emission of lubricant from the drive.
- Open up the Ermeto screw connection in the adapter plate and check for any lubricant emission inside the adapter plate.
- If a leak is detected, remove the lubricant and re-check the inside of the adapter plate after brief operation. Lubricant discharge should stop after a short time.
- In case lubricant still is emitted, shut down the gearbox and consult our Customer Service department.

7.2.4 Replacing the gearbox

- Replace the gearbox:
 - When 90% of the calculated life of the output bearing has been reached (see Chapter 3.6 "Dimensioning" or "Cymex[®]" design).
 - At the latest after a total of 20,000 operating hours.
- ① Alternatively, the gearbox can be checked by **WITTENSTEIN alpha GmbH** and if necessary, approved for further operation.
- ① For removal of the gearbox, please also refer to the Chapter 8 "Disassembly".

7.3 Startup after maintenance work

- Clean the outside of the gearbox.
- Attach all safety devices.
- Do a trial run before releasing the gearbox again for operation.

7.4 Disposal

- Dispose of the gearbox at the recycling sites intended for this purpose.
 - ① Observe the applicable national regulations concerning disposal.
 - ① Consult our Customer Service department for supplementary information on disposal of the gearbox.

8 Disassembly

- If you need to remove the gearbox for maintenance or replacement, complete the steps in this chapter.
- Read the general safety instructions before beginning to work (see Chapter 2.5 "General safety instructions").
- Secure the higher-level machine against restarting and unintentional movements during assembly and maintenance work (e.g. uncontrolled lowering of lifting axes).

8.1 Removing the components of the output side

The output side has different shapes depending on the product type:

- Smooth shaft
- Shaft with shaft key
- Splined shaft (DIN 5480)
- Blind hollow shaft / hollow shaft / hollow shaft interface / flange hollow shaft
- Flange
- With mounted output pinion

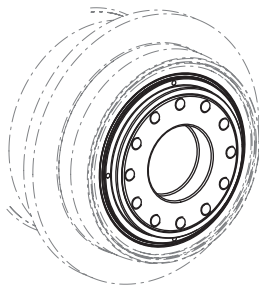

- Unscrew the screws in the flange to remove the components of the **flange / flanged hollow shaft**.

- For details on how to remove the components of **slip-on shaft / hollow shaft / hollow shaft interface**, refer to the instructions in Chapter 8.1.1 "Removing the shrink disc".

There are customer-specific designs for all other types of outputs. The removal of these outputs cannot be described here.

8.1.1 Removing the shrink disc

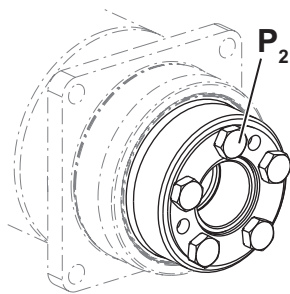

- Loosen the clamping screws [P₂] one after another in multiple circular passes.
- If the outer ring does not detach itself from the inner ring, remove a few of the clamping screws and screw into the adjacent extraction threads.
- Remove the gearbox from its position with care, so as to safeguard the gearbox and adjacent parts against damage.

8.2 Disassembling the gearbox with the motor from the machine

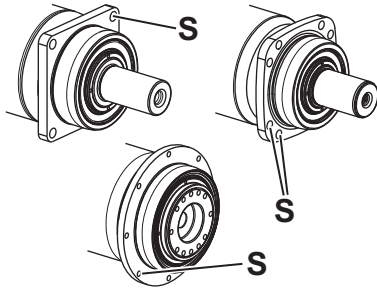

- Disconnect the electrical connections of the motor.
- Secure the gearbox and the motor so it cannot fall.
- Loosen the screws [S] connecting the gearbox to the whole machine.
- Remove the gearbox from its position with care, so as to safeguard the gearbox and adjacent parts against damage.

8.3 Disassembling the motor

For motor-mounted gearboxes, the motor shaft and the gear input shaft were connected using a clamping hub. A slotted bushing was additionally used for certain motor shaft diameters and applications.

		Designation
	H ₁	Clamping bolt, eccentric
	H ₂	Clamping bolt, central
	I	Clamping ring
	J	Bushing
	K	Keyed motor shaft
	L	Motor shaft with shaft key
	L ₁	Shaft key

Tbl-12: Arrangement of motor shaft, clamping bolt and bushing

NOTICE

Clamping forces can damage the motor and the gearbox.

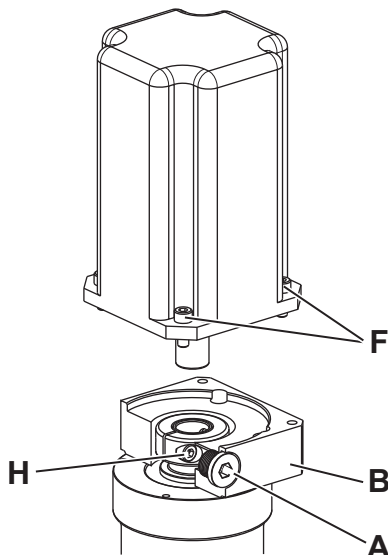

- Ensure that the motor is removed in a vertical position.



- Remove the plug [A] from the mounting bore in the adapter plate [B].
- Turn the gearbox until the clamping bolt [H] can be reached via the mounting bore.
- Loosen the clamping bolt [H] in the clamping ring.
- Loosen the screws [F] between motor and adapter plate.
 - ⓘ The motor must be able to be withdrawn without effort.
- Pull the motor off the gearbox.

The adapter plate and the bushing are part of the gearbox. Include these parts when returning the gearbox.

9 Malfunctions

NOTICE		
	<p>Changed operational behavior can be an indication of existing damage to the gearbox or can cause damage to the gearbox.</p> <ul style="list-style-type: none"> Do not put the gearbox back into operation until the cause of the malfunction has been rectified. 	
	<p>Rectifying of malfunctions may only be done by specially trained technicians.</p>	
Fault	Possible cause	Solution
Increased operating temperature	The gearbox is not suited for the task.	Check the technical data.
	Motor is heating the gearbox.	Check the wiring of the motor.
		Ensure adequate cooling.
	Change the motor.	
Ambient temperature too high.	Ensure adequate cooling.	
Increased noises during operation / increased vibrations	Distortion in motor mounting, misalignment	Consult our Customer Service department.
	Damaged bearings	
	Damaged gear teeth	
Loss of lubricant	Excessive amount of lubricant	Wipe off discharged lubricant and continue to watch the gearbox. Lubricant discharge should stop after a short time.
	Only in the case of grease lubrication: "Seeping" at the output	in accordance with Chapter 5.1 "Preparations"
	Seals not tight	Consult our Customer Service department.
Clamp connection of the clamping hub is slipping	Clamping bolt not tightened properly	Check the shaft seat and hub bore for damage. Replace damaged parts. Check the clamping bolt for proper tightening torque and secure it against loosening by itself. Check the operating parameters.
	Operating parameters not maintained	

Tbl-13: Malfunctions

10 Appendix

10.1 Specifications for mounting to a motor

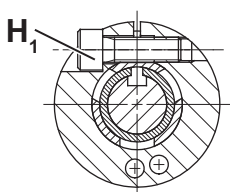
		Designation
	H ₁	Clamping bolt, eccentrical

Tbl-14: Arrangement of motor shaft, clamping bolt and bushing

Tightening torque for clamping bolt (H ₁)					
Ordering code: xxxxxxxx-xxx-xxxxx-x(.) [*] x-xx (see Chapter 3.2 "Name plate")					
Clamping hub Ø ¹⁾ [mm]	(.) [*] Code letter	Width across flats [mm]	Tightening torque [Nm]		
			Coaxial	Angle	
				Coupling "K" ²⁾	Clamping hub socket "S" ²⁾
8	Z	2.5	2	—	—
9	A	2.5	2	—	—
11	B	3	4.1	—	4.1
14	C	4	9.5	8.5	9.5
16	D	5	14	14	—
19	E	5	14	14	14
24	G	6	35	35	35
28 ³⁾	H	5	14	—	—
28 ⁴⁾	H	6	—	35	—
32	I	8	79	69	—
38	K	8	79	69	79
48	M	10	135	86	135
55	N	10	135	—	—
60	O	14	330	—	—

¹⁾ The availability of particular clamping hub diameters can be found in the catalog.
²⁾ Ordering code:xxxx-xxx-xxxxx-xxx-x(.); Motor connection
³⁾ only applies for coaxial gearboxes
⁴⁾ only applies for angular gearboxes

Tbl-15: Specifications for clamping bolt, eccentrical [H₁]

10.2 Specifications for mounting to a machine

The gearbox may only be operated in the approved mounting position.

Further information on the mounting position can be found in chapters 10.4.1 "Mounting position" and 10.4.2 "Impermissible operating conditions".

10.2.1 Specifications for mounting with through-holes

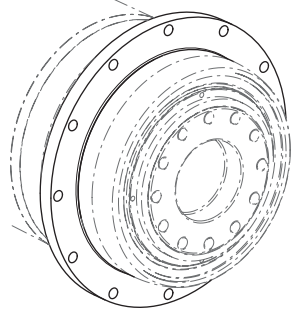
Ordering code: TK..xxxx-xFx-xxxxx-xxx-xx; Standard					
	Gearbox size TK..	Hole circle Ø [mm]	Quantity x diameter [] x [mm]	Screw size / Property class	Tightening torque [Nm]
	004	79	8 x 4.5	M4 / 12.9	4.55
	010	109	8 x 5.5	M5 / 12.9	9
	025	135	8 x 5.5	M5 / 12.9	9
	050	168	12 x 6.6	M6 / 12.9	15.4
	110	233	12 x 9	M8 / 12.9	37.5

Tbl-16: Specifications for mounting to a machine TK⁺

10.3 Specifications for mounting to the output side

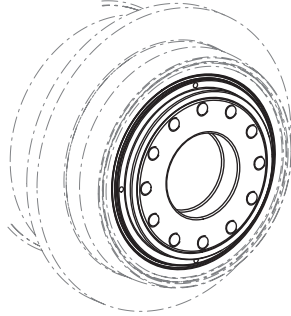
Ordering code: TK..xxxx-xFx-xxxxx-xxx-xx; Standard				
Output flange	Gearbox size TK..	Hole circle Ø [mm]	Quantity x thread x screw depth [] x [mm] x [mm]	Tightening torque [Nm] Property class 12.9
	004	31.5	8 x M5 x 7	9
	010	50	8 x M6 x 10	15.4
	025	63	12 x M6 x 12	15.4
	050	80	12 x M8 x 15	37.5
	110	125	12 x M10 x 20	73.5

Tbl-17: Thread in output flange TK⁺

Maximum permitted axial forces
Mounting by pressing or shrink-fitting is not intended for this product type.

Tbl-18: Specifications for mounting to the output side

10.4 Specifications for startup and operation

Ambient temperature		
Product type	Minimum temperature [°C]	Maximum temperature [°C]
TK ⁺	0	+40
Operating temperature		
Product type	Max. permissible housing temperature [°C]	
TK ⁺	+80	

Tbl-19: Ambient temperature / Operating temperature

10.4.1 Mounting position



Improper use can cause damage to the gearbox and cause ignition hazards.

- Ensure that the gearbox is mounted in the mounting positions depicted below to ensure the lubrication of all gearbox components. In the case of application conditions and mounting positions that differ from those depicted below (e.g. inclinations around an axis of these mounting positions), please contact our Customer Service department.

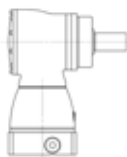

Mounting position B5/V3 (output shaft horizontal, motor shaft upwards)

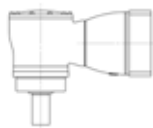

Mounting position V1/B5 (output shaft downwards, motor shaft horizontal)

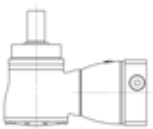

Mounting position V3/B5 (output shaft upwards, motor shaft horizontal)

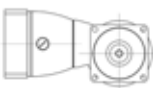

Mounting position B5/B5 (output shaft horizontal, motor shaft horizontal)

10.4.2 Impermissible operating conditions

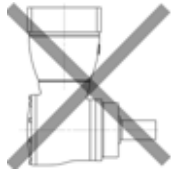

The following operating conditions are not permitted:

- Mounting position B5/V1 (output shaft horizontal, motor shaft downwards)
- Lateral forces or bending torques acting on the blind hollow shaft / hollow shaft / hollow shaft interface. If necessary, install external bearing points for the load shaft. In case of unclear installation situations, contact **WITTENSTEIN alpha GmbH**.
- Co-riding the gearbox on the drive axle is prohibited. Exceptions require a written approval and technical statement from **WITTENSTEIN alpha GmbH**.
- Use in continuous duty (S1 duty: power-on time greater than 60% or longer than 20 minutes)

10.5 Tightening torques for common thread sizes in general mechanical engineering

The specified tightening torques for set screws and nuts are calculated values and are based on the following conditions:

- Calculation in accordance with VDI 2230 (February 2003 version)
- Friction value for thread and contact surfaces $\mu=0.10$
- Utilization of the yield stress 90%
- Torque tools type II classes A and D in accordance with ISO 6789

The settings are values rounded to usual commercial scale gradations or setting possibilities.

- Use the **exact** values in this table to set your tools.

Property class screw / nut	Tightening torque [Nm] with thread												
	M3	M4	M5	M6	M8	M10	M12	M14	M16	M18	M20	M22	M24
8.8 / 8	1.15	2.64	5.2	9.0	21.5	42.5	73.5	118	180	258	362	495	625
10.9 / 10	1.68	3.88	7.6	13.2	32.0	62.5	108	173	264	368	520	700	890
12.9 / 12	1.97	4.55	9.0	15.4	37.5	73.5	126	202	310	430	605	820	1040

Tbl-20: Tightening torques for set screws and nuts

10.6 Technical specifications

10.6.1 Technical specifications for TK⁺ 004 for use in areas with explosion hazards

Technical specifications for TK ⁺ 004, 1-stage					
Ratio i	3	4	5	7	10
Max. acceleration torque T_{2B} [Nm] (max. 1000 cycles per hour)	24	24	24	20	16
Nominal output torque T_{2N} [Nm] (At n _{1N})	17.5	17.5	17.5	16	12
Emergency stop torque T_{2Not} [Nm] (1000 times possible during the service life of the gearbox)	40	40	40	40	40
Permissible average input speed n_{1N} [min⁻¹] (At T _{2N})	1800	1900	2200	2200	2200
Max. input speed n_{1Max} [min⁻¹]	6000	6000	6000	6000	6000
Average no-load running torque T₀₁₂ [Nm] (For n ₁ =3000 min ⁻¹ and gearbox temperature 20 °C) ^a	1.4	1.3	1.2	1.4	1.3
Max. backlash j_t [arcmin]	≤ 5				
Torsional rigidity C_{t21} [Nm/arcmin]	2.6	2.8	3.0	2.6	2.3
Max. axial force F_{2AMax} [N]^b	1650				
Max. tilting moment M_{2KMax} [Nm]	175				
Service life L_h [h]	See Chapter 7.2.4 "Replacing the gearbox"				
Weight incl. standard adapter plate m [kg]	2.9				
Operating noise L_{PA} [dB(A)] (For n ₁ = 3000 min ⁻¹ w/o load)	≤ 64				
Max. permissible housing temperature [°C]	+80				
Ambient temperature [°C]	See Chapter 10.4 "Specifications for startup and operation"				
Lubrication	synthetic gear oil (see also Chapter 7.1 "Maintenance schedule")				
Direction of rotation	In- and output opposite directions				
Mass moment of inertia J₁ [kgcm²] Refers to the drive; Bore diameter of the clamping hub: 14 mm	0.57	0.46	0.41	0.37	0.35
Mass moment of inertia J₁ [kgcm²] Refers to the drive; Bore diameter of the clamping hub: 19 mm	0.92	0.82	0.76	0.72	0.70
^a No-load running torques diminish during operation					
^b Refers to the center of the output shaft or flange					

Tbl-21: TK⁺ 004, 1-stage: Technical data for use in potentially explosive atmospheres

Technical specifications for TK ⁺ 004, 2-stage										
Ratio i	12	16	20	25	28	35	40	50	70	100
Max. acceleration torque T_{2B} [Nm] (max. 1000 cycles per hour)	24	24	24	24	24	24	24	24	20	16
Nominal output torque T_{2N} [Nm] (At n _{1N})	17.5	17.5	17.5	17.5	17.5	17.5	17.5	17.5	16	12
Emergency stop torque T_{2Not} [Nm] (1000 times possible during the service life of the gearbox)	40	40	40	40	40	40	40	40	40	40
Permissible average input speed n_{1N} [min⁻¹] (At T _{2N})	3150	3150	3150	3150	3150	3150	3150	3450	3950	3950
Max. input speed n_{1Max} [min⁻¹]	6000	6000	6000	6000	6000	6000	6000	6000	6000	6000
Average no-load running torque T₀₁₂ [Nm] (For n ₁ =3000 min ⁻¹ and gearbox temperature 20 °C) ^a	0.2	0.2	0.2	0.2	0.2	0.2	0.1	0.1	0.1	0.1
Max. backlash j_t [arcmin]	≤ 5									
Torsional rigidity C_{t21} [Nm/arcmin]	2.8	2.8	2.8	2.8	2.8	2.8	2.8	3.0	2.6	2.3
Max. axial force F_{2AMax} [N]^b	1650									
Max. tilting moment M_{2KMax} [Nm]	175									
Service life L_h [h]	See Chapter 7.2.4 "Replacing the gearbox"									
Weight incl. standard adapter plate m [kg]	3.2									
Operating noise L_{PA} [dB(A)] (For n ₁ = 3000 min ⁻¹ w/o load)	≤ 64									
Max. permissible housing temperature [°C]	+80									
Ambient temperature [°C]	See Chapter 10.4 "Specifications for startup and operation"									
Lubrication	synthetic gear oil (see also Chapter 7.1 "Maintenance schedule")									

Technical specifications for TK ⁺ 004, 2-stage										
Ratio i	12	16	20	25	28	35	40	50	70	100
Direction of rotation	In- and output opposite directions									
Mass moment of inertia J ₁ [kgcm ²] Refers to the drive; Bore diameter of the clamping hub: 11 mm	0.09	0.09	0.08	0.07	0.06	0.06	0.06	0.06	0.06	0.06
Mass moment of inertia J ₁ [kgcm ²] Refers to the drive; Bore diameter of the clamping hub: 14 mm	0.21	0.20	0.19	0.19	0.18	0.18	0.17	0.17	0.17	0.17
^a No-load running torques diminish during operation ^b Refers to the center of the output shaft or flange										

Tbl-22: TK⁺ 004, 2-stage: Technical data for use in potentially explosive atmospheres

10.6.2 Technical specifications for TK⁺ 010 for use in areas with explosion hazards

Technical specifications for TK ⁺ 010, 1-stage					
Ratio i	3	4	5	7	10
Max. acceleration torque T _{2B} [Nm] (max. 1000 cycles per hour)	56	56	56	48	40
Nominal output torque T _{2N} [Nm] (At n _{1N})	37	37	37	33	30
Emergency stop torque T _{2Not} [Nm] (1000 times possible during the service life of the gearbox)	95	95	95	95	95
Permissible average input speed n _{1N} [min ⁻¹] (At T _{2N})	1575	1650	1875	1875	1875
Max. input speed n _{1Max} [min ⁻¹]	3000	4000	6000	6000	6000
Average no-load running torque T ₀₁₂ [Nm] (For n ₁ =3000 min ⁻¹ and gearbox temperature 20 °C) ^a	2.4	2.0	1.8	2.4	2.2
Max. backlash j _t [arcmin]	≤ 4				
Torsional rigidity C _{t21} [Nm/arcmin]	6.0	7.0	8.0	8.0	8.0
Max. axial force F _{2AMax} [N] ^b	2350				
Max. tilting moment M _{2KMax} [Nm]	300				
Service life L _h [h]	See Chapter 7.2.4 "Replacing the gearbox"				
Weight incl. standard adapter plate m [kg]	5.3				
Operating noise L _{PA} [dB(A)] (For n ₁ = 3000 min ⁻¹ w/o load)	≤ 66				
Max. permissible housing temperature [°C]	+80				

Technical specifications for TK ⁺ 010, 1-stage					
Ratio i	3	4	5	7	10
Ambient temperature [°C]	See Chapter 10.4 "Specifications for startup and operation"				
Lubrication	synthetic gear oil (see also Chapter 7.1 "Maintenance schedule")				
Direction of rotation	In- and output opposite directions				
Mass moment of inertia J_1 [kgcm ²] Refers to the drive; Bore diameter of the clamping hub: 19 mm	1.81	1.39	1.18	1.02	0.93
Mass moment of inertia J_1 [kgcm ²] Refers to the drive; Bore diameter of the clamping hub: 28 mm	3.22	2.80	2.60	2.43	2.34
^a No-load running torques diminish during operation ^b Refers to the center of the output shaft or flange					

Tbl-23: TK⁺ 010, 1-stage: Technical data for use in potentially explosive atmospheres

Technical specifications for TK ⁺ 010, 2-stage										
Ratio i	12	16	20	25	28	35	40	50	70	100
Max. acceleration torque T_{2B} [Nm] (max. 1000 cycles per hour)	56	56	56	56	56	56	56	56	48	40
Nominal output torque T_{2N} [Nm] (At n_{1N})	37	37	37	37	37	37	37	37	33	30
Emergency stop torque T_{2Not} [Nm] (1000 times possible during the service life of the gearbox)	95	95	95	95	95	95	95	95	95	95
Permissible average input speed n_{1N} [min ⁻¹] (At T_{2N})	3100	3100	3100	3100	3100	3100	3100	3400	4000	4000
Max. input speed n_{1Max} [min ⁻¹]	6000	6000	6000	6000	6000	6000	6000	6000	6000	6000
Average no-load running torque T_{012} [Nm] (For $n_1=3000$ min ⁻¹ and gearbox temperature 20 °C) ^a	0.4	0.4	0.3	0.3	0.3	0.3	0.1	0.1	0.1	0.1
Max. backlash j_t [arcmin]	≤ 4									
Torsional rigidity C_{t21} [Nm/arcmin]	7.0	7.0	7.0	7.0	7.0	7.0	7.0	8.0	8.0	8.0
Max. axial force F_{2AMax} [N] ^b	2350									
Max. tilting moment M_{2KMax} [Nm]	300									

Technical specifications for TK ⁺ 010, 2-stage										
Ratio i	12	16	20	25	28	35	40	50	70	100
Service life L_h [h]	See Chapter 7.2.4 "Replacing the gearbox"									
Weight incl. standard adapter plate m [kg]	6.1									
Operating noise L_{PA} [dB(A)] (For $n_1 = 3000 \text{ min}^{-1}$ w/o load)	≤ 66									
Max. permissible housing temperature [°C]	+80									
Ambient temperature [°C]	See Chapter 10.4 "Specifications for startup and operation"									
Lubrication	synthetic gear oil (see also Chapter 7.1 "Maintenance schedule")									
Direction of rotation	In- and output opposite directions									
Mass moment of inertia J_1 [kgcm ²] Refers to the drive; Bore diameter of the clamping hub: 14 mm	0.31	0.28	0.24	0.23	0.21	0.20	0.19	0.18	0.18	0.18
Mass moment of inertia J_1 [kgcm ²] Refers to the drive; Bore diameter of the clamping hub: 19 mm	0.75	0.72	0.68	0.68	0.63	0.63	0.63	0.63	0.63	0.63
^a No-load running torques diminish during operation ^b Refers to the center of the output shaft or flange										

TbI-24: TK⁺ 010, 2-stage: Technical data for use in potentially explosive atmospheres

10.6.3 Technical specifications for TK⁺ 025 for use in areas with explosion hazards

Technical specifications for TK ⁺ 025, 1-stage					
Ratio i	3	4	5	7	10
Max. acceleration torque T_{2B} [Nm] (max. 1000 cycles per hour)	125	125	125	95	85
Nominal output torque T_{2N} [Nm] (At n_{1N})	75	75	75	60	55
Emergency stop torque T_{2Not} [Nm] (1000 times possible during the service life of the gearbox)	200	200	200	200	200
Permissible average input speed n_{1N} [min ⁻¹] (At T_{2N})	1400	1400	1600	1400	1400
Max. input speed n_{1Max} [min ⁻¹]	2500	3300	4500	4500	4500
Average no-load running torque T_{012} [Nm] (For $n_1 = 3000 \text{ min}^{-1}$ and gearbox temperature 20 °C) ^a	4.6	3.6	2.8	4.2	3.4
Max. backlash j_t [arcmin]	≤ 4				

Technical specifications for TK ⁺ 025, 1-stage					
Ratio i	3	4	5	7	10
Torsional rigidity C_{t21} [Nm/arcmin]	12	13	16	16	16
Max. axial force F_{2AMax} [N]^b	3950				
Max. tilting moment M_{2KMax} [Nm]	580				
Service life L_h [h]	See Chapter 7.2.4 "Replacing the gearbox"				
Weight incl. standard adapter plate m [kg]	8.9				
Operating noise L_{PA} [dB(A)] (For n ₁ = 3000 min ⁻¹ w/o load)	≤ 66				
Max. permissible housing temperature [°C]	+80				
Ambient temperature [°C]	See Chapter 10.4 "Specifications for startup and operation"				
Lubrication	synthetic gear oil (see also Chapter 7.1 "Maintenance schedule")				
Direction of rotation	In- and output opposite directions				
Mass moment of inertia J₁ [kgcm²] Refers to the drive; Bore diameter of the clamping hub: 28 mm	5.5	4.3	3.6	3.1	2.9
Mass moment of inertia J₁ [kgcm²] Refers to the drive; Bore diameter of the clamping hub: 38 mm	12.7	11.5	10.9	10.4	10.1
^a No-load running torques diminish during operation					
^b Refers to the center of the output shaft or flange					

Tbl-25: TK⁺ 025, 1-stage: Technical data for use in potentially explosive atmospheres

Technical specifications for TK ⁺ 025, 2-stage										
Ratio i	12	16	20	25	28	35	40	50	70	100
Max. acceleration torque T_{2B} [Nm] (max. 1000 cycles per hour)	125	125	125	125	125	125	125	125	95	85
Nominal output torque T_{2N} [Nm] (At n _{1N})	75	75	75	75	75	75	75	75	60	55
Emergency stop torque T_{2Not} [Nm] (1000 times possible during the service life of the gearbox)	200	200	200	200	200	200	200	200	200	200
Permissible average input speed n_{1N} [min⁻¹] (At T _{2N})	2700	2700	2700	2700	2700	2700	2700	3100	3700	3700
Max. input speed n_{1Max} [min⁻¹]	4500	4500	4500	4500	4500	4500	4500	4500	4500	4500

Technical specifications for TK ⁺ 025, 2-stage										
Ratio i	12	16	20	25	28	35	40	50	70	100
Average no-load running torque T₀₁₂ [Nm] (For n ₁ =3000 min ⁻¹ and gearbox temperature 20 °C) ^a	0.7	0.7	0.6	0.5	0.5	0.4	0.2	0.2	0.2	0.2
Max. backlash j_t [arcmin]	≤ 4									
Torsional rigidity C_{t21} [Nm/arcmin]	13.0	13.0	13.0	13.0	13.0	13.0	13.0	16.0	16.0	16.0
Max. axial force F_{2AMax} [N] ^b	3950									
Max. tilting moment M_{2KMax} [Nm]	580									
Service life L_h [h]	See Chapter 7.2.4 "Replacing the gearbox"									
Weight incl. standard adapter plate m [kg]	10.6									
Operating noise L_{PA} [dB(A)] (For n ₁ = 3000 min ⁻¹ w/o load)	≤ 66									
Max. permissible housing temperature [°C]	+80									
Ambient temperature [°C]	See Chapter 10.4 "Specifications for startup and operation"									
Lubrication	synthetic gear oil (see also Chapter 7.1 "Maintenance schedule")									
Direction of rotation	In- and output opposite directions									
Mass moment of inertia J₁ [kgcm²] Refers to the drive; Bore diameter of the clamping hub: 19 mm	1.08	1.01	0.88	0.85	0.76	0.75	0.70	0.69	0.69	0.68
Mass moment of inertia J₁ [kgcm²] Refers to the drive; Bore diameter of the clamping hub: 24 mm	2.65	2.57	2.44	2.42	2.32	2.31	2.26	2.25	2.25	2.25
^a No-load running torques diminish during operation										
^b Refers to the center of the output shaft or flange										

Tbl-26: TK⁺ 025, 2-stage: Technical data for use in potentially explosive atmospheres

10.6.4 Technical specifications for TK⁺ 050 for use in areas with explosion hazards

Technical specifications for TK ⁺ 050, 1-stage					
Ratio i	3	4	5	7	10
Max. acceleration torque T_{2B} [Nm] (max. 1000 cycles per hour)	190	190	205	185	170
Nominal output torque T_{2N} [Nm] (At n _{1N})	120	120	130	130	130
Emergency stop torque T_{2Not} [Nm] (1000 times possible during the service life of the gearbox)	400	420	420	420	400
Permissible average input speed n_{1N} [min⁻¹] (At T _{2N})	1200	1200	1400	1300	1400
Max. input speed n_{1Max} [min⁻¹]	2000	2500	3500	4200	4200
Average no-load running torque T₀₁₂ [Nm] (For n ₁ =3000 min ⁻¹ and gearbox temperature 20 °C) ^a	8.4	6.2	5.4	9	6.6
Max. backlash j_t [arcmin]	≤ 4				
Torsional rigidity C_{t21} [Nm/arcmin]	36	40	46	44	42
Max. axial force F_{2AMax} [N] ^b	6900				
Max. tilting moment M_{2KMax} [Nm]	1180				
Service life L_h [h]	See Chapter 7.2.4 "Replacing the gearbox"				
Weight incl. standard adapter plate m [kg]	22				
Operating noise L_{PA} [dB(A)] (For n ₁ = 3000 min ⁻¹ w/o load)	≤ 68				
Max. permissible housing temperature [°C]	+80				
Ambient temperature [°C]	See Chapter 10.4 "Specifications for startup and operation"				
Lubrication	synthetic gear oil (see also Chapter 7.1 "Maintenance schedule")				
Direction of rotation	In- and output opposite directions				
Mass moment of inertia J₁ [kgcm²] Refers to the drive; Bore diameter of the clamping hub: 38 mm	28.4	21.0	17.6	14.7	13.1
^a No-load running torques diminish during operation					
^b Refers to the center of the output shaft or flange					

Tbl-27: TK⁺ 050, 1-stage: Technical data for use in potentially explosive atmospheres

Technical specifications for TK ⁺ 050, 2-stage										
Ratio i	12	16	20	25	28	35	40	50	70	100
Max. acceleration torque T_{2B} [Nm] (max. 1000 cycles per hour)	190	190	190	205	190	205	190	205	185	170
Nominal output torque T_{2N} [Nm] (At n _{1N})	120	120	120	120	120	120	120	130	130	130
Emergency stop torque T_{2Not} [Nm] (1000 times possible during the service life of the gearbox)	400	420	420	420	420	420	420	420	420	400
Permissible average input speed n_{1N} [min⁻¹] (At T _{2N})	2600	2600	2600	2600	2600	2600	2600	2800	2800	3500
Max. input speed n_{1Max} [min⁻¹]	4500	4500	4500	4500	4500	4500	4500	4500	4500	4500
Average no-load running torque T₀₁₂ [Nm] (For n ₁ =3000 min ⁻¹ and gearbox temperature 20 °C) ^a	1.4	0.9	0.7	0.5	0.5	0.4	0.4	0.3	0.3	0.3
Max. backlash j_t [arcmin]	≤ 4									
Torsional rigidity C_{t12} [Nm/arcmin]	29	29	29	29	29	29	29	31	31	31
Max. axial force F_{2AMax} [N] ^b	6900									
Max. tilting moment M_{2KMax} [Nm]	1180									
Service life L_h [h]	See Chapter 7.2.4 "Replacing the gearbox"									
Weight incl. standard adapter plate m [kg]	26									
Operating noise L_{PA} [dB(A)] (For n ₁ = 3000 min ⁻¹ w/o load)	≤ 68									
Max. permissible housing temperature [°C]	+80									
Ambient temperature [°C]	See Chapter 10.4 "Specifications for startup and operation"									
Lubrication	synthetic gear oil (see also Chapter 7.1 "Maintenance schedule")									

Technical specifications for TK ⁺ 050, 2-stage										
Ratio i	12	16	20	25	28	35	40	50	70	100
Direction of rotation	In- and output opposite directions									
Mass moment of inertia J₁ [kgcm²] Refers to the drive; Bore diameter of the clamping hub: 24 mm	4.43	3.97	3.36	3.22	2.82	2.75	2.50	2.47	2.44	2.42
Mass moment of inertia J₁ [kgcm²] Refers to the drive; Bore diameter of the clamping hub: 38 mm	11.3	10.9	10.3	10.1	9.74	9.66	9.41	9.38	9.35	9.33
^a No-load running torques diminish during operation ^b Refers to the center of the output shaft or flange										

Tbl-28: TK⁺ 050, 2-stage: Technical data for use in potentially explosive atmospheres

10.6.5 Technical specifications for TK⁺ 110 for use in areas with explosion hazards

Technical specifications for TK ⁺ 110, 1-stage					
Ratio i	3	4	5	7	10
Max. acceleration torque T_{2B} [Nm] (max. 1000 cycles per hour)	400	400	400	350	300
Nominal output torque T_{2N} [Nm] (At n _{1N})	250	250	250	230	220
Emergency stop torque T_{2Not} [Nm] (1000 times possible during the service life of the gearbox)	900	900	900	900	900
Permissible average input speed n_{1N} [min⁻¹] (At T _{2N})	900	1100	1200	1100	1100
Max. input speed n_{1Max} [min⁻¹]	1300	1700	2200	3000	3000
Average no-load running torque T₀₁₂ [Nm] (For n ₁ =3000 min ⁻¹ and gearbox temperature 20 °C) ^a	17.5	14.5	12	18	15
Max. backlash j_t [arcmin]	≤ 4				
Torsional rigidity C_{t21} [Nm/arcmin]	76	87	99	97	96
Max. axial force F_{2AMax} [N] ^b	9900				
Max. tilting moment M_{2KMax} [Nm]	2250				
Service life L_h [h]	See Chapter 7.2.4 "Replacing the gearbox"				
Weight incl. standard adapter plate m [kg]	48				
Operating noise L_{PA} [dB(A)] (For n ₁ = 3000 min ⁻¹ w/o load)	≤ 68				
Max. permissible housing temperature [°C]	+80				

Technical specifications for TK ⁺ 110, 1-stage					
Ratio i	3	4	5	7	10
Ambient temperature [°C]	See Chapter 10.4 "Specifications for startup and operation"				
Lubrication	synthetic gear oil (see also Chapter 7.1 "Maintenance schedule")				
Direction of rotation	In- and output opposite directions				
Mass moment of inertia J_1 [kgcm ²] Refers to the drive; Bore diameter of the clamping hub: 48 mm	96.5	64.6	50.5	38.2	31.8
^a No-load running torques diminish during operation ^b Refers to the center of the output shaft or flange					

Tbl-29: TK⁺ 110, 1-stage: Technical data for use in potentially explosive atmospheres

Technical specifications for TK ⁺ 110, 2-stage										
Ratio i	12	16	20	25	28	35	40	50	70	100
Max. acceleration torque T_{2B} [Nm] (max. 1000 cycles per hour)	400	400	400	400	400	400	400	400	350	300
Nominal output torque T_{2N} [Nm] (At n_{1N})	250	250	250	250	250	250	250	250	230	220
Emergency stop torque T_{2Not} [Nm] (1000 times possible during the service life of the gearbox)	900	900	900	900	900	900	900	900	900	900
Permissible average input speed n_{1N} [min ⁻¹] (At T_{2N})	1900	1900	1900	1900	1900	1900	1900	2050	2300	2450
Max. input speed n_{1Max} [min ⁻¹]	4000	4000	4000	4000	4000	4000	4000	4000	4000	4000
Average no-load running torque T_{012} [Nm] (For $n_1=3000$ min ⁻¹ and gearbox temperature 20 °C) ^a	3.6	2.8	2.2	1.9	1.6	1.4	1.1	1.1	1.1	1.1
Max. backlash j_t [arcmin]	≤ 4									
Torsional rigidity C_{t21} [Nm/arcmin]	87	87	87	87	87	87	87	99	97	96
Max. axial force F_{2AMax} [N] ^b	9900									
Max. tilting moment M_{2KMax} [Nm]	2250									
Service life L_h [h]	See Chapter 7.2.4 "Replacing the gearbox"									
Weight incl. standard adapter plate m [kg]	54									

Technical specifications for TK ⁺ 110, 2-stage										
Ratio i	12	16	20	25	28	35	40	50	70	100
Operating noise L_{PA} [dB(A)] (For n ₁ = 3000 min ⁻¹ w/o load)	≤ 68									
Max. permissible housing temperature [°C]	+80									
Ambient temperature [°C]	See Chapter 10.4 "Specifications for startup and operation"									
Lubrication	synthetic gear oil (see also Chapter 7.1 "Maintenance schedule")									
Direction of rotation	In- and output opposite directions									
Mass moment of inertia J₁ [kgcm²] Refers to the drive; Bore diameter of the clamping hub: 38 mm	16.8	14.8	12.9	12.3	11.2	10.9	10.3	10.1	10.0	9.93
Mass moment of inertia J₁ [kgcm²] Refers to the drive; Bore diameter of the clamping hub: 48 mm	31.5	29.5	27.6	27.0	25.9	25.6	25.0	24.8	24.7	24.6
^a No-load running torques diminish during operation										
^b Refers to the center of the output shaft or flange										

Tbl-30: TK⁺ 110, 2-stage: Technical data for use in potentially explosive atmospheres





10.7 Declaration of Conformity

**EU Declaration of Conformity**

(Translation of original text)

We, **WITTENSTEIN alpha GmbH**
 Walter-Wittenstein-Straße 1
 97999 Igersheim
 GERMANY

hereby declare on our sole responsibility that the product designated below is in conformity with the essential safety and health protection requirements of the relevant EU Directives.

Description:	SK ⁺ HG ⁺ TK ⁺	
Size:	SK ⁺ 060, SK ⁺ 075, SK ⁺ 100, SK ⁺ 140, SK ⁺ 180 HG ⁺ 060, HG ⁺ 075, HG ⁺ 100, HG ⁺ 140, HG ⁺ 180 TK ⁺ 004, TK ⁺ 010, TK ⁺ 025, TK ⁺ 050, TK ⁺ 110	
Gearbox variant:	M	
Gearbox model:	F	
Serial number:	SN: 1234567, consecutive number (7 digits)	
Relevant EU Directive:	2014/34/EU (ATEX) 2011/65/EU (RoHS)	
Applied harmonized standards:	EN ISO 80079-36:2016 EN ISO 80079-37:2016 EN IEC 60079-0:2018	
Marking:	 II 2G Ex h IIC T3 Gb X	and
	 II 2D Ex h IIIC T150 °C Db X	
Marking of TK ⁺ 110:	 II 2G Ex h IIB T3 Gb X	and
	 II 2D Ex h IIIC T150 °C Db X	

The technical documentation with the registration number 17 ATEX D070 holds the notified body Konformitätsbewertungsstelle der Physikalisch-Technischen Bundesanstalt (PTB), NB 0102.

Igersheim, 25 October 2019
 city and date

 Norbert Pastoors, Managing Director

Document No.: 2097-D035547

Rev.: 04

Revision history

Revision	Date	Comment	Chapter
01	18.12.2009	New version	All
02	31.08.2010	2-stage design	1, 3, 5, 7, 9
03	27.05.2015	Lubricant	3.1, 9.6
04	10.03.2016	2014/34/EU	2.1, 2.4, 3.1, 3.2, 3.4.1, 9.7
05	19.12.2019	EN ISO 80079	All
06	29.01.2024	ATEX marking	3.2



alpha

WITTENSTEIN alpha GmbH · Walter-Wittenstein-Straße 1 · 97999 Igersheim · Germany
Tel. +49 7931 493-0 · info@wittenstein.de

WITTENSTEIN – one with the future

www.wittenstein-alpha.de